

THE ROYAL VARIETY PERFORMANCE.



The Journal of the British Broadcasting Corporation.

Vol. 14. No. 177. [Registered at the G.P.O. as a Newspaper.]

FEBRUARY 18, 1927.

Every Friday. Two Pence.

The Unseen Congregation.

By Sir ARTHUR YAPP.

EXAMINING the pages of history we find that there are always people who decry new inventions, who consider that because a thing is new, and, therefore, unfamiliar and unproved, it is more likely to wield a harmful than a beneficial influence. From the days when the labours of scientists were hampered by a ridiculous fear on the part of the public that new discoveries were the product of wizardry, to the present time when radio is the latest arrival from the unknown, these folk have been busy hindering the march of progress. And to-day they are as active as ever, and their cry is that radio is exercising a subtly harmful influence on the attitude and behaviour of youth.

Believing that the slippered ease of radio concerts and religious services is responsible for the decrease in church attendance, these anxious souls maintain that the radio service will gradually supplant the age-old practice of worshipping together in a church. But serious as is this prospect, they consider that it is of little moment when compared with the general slackening of discipline and religious fervour which may follow as a direct result. In years past, time has usually disproved such gloomy prophecies, no matter at what innovation they were directed, but this does not prove that there is no justification for them in the present instance. Is radio really exercising a harmful influence on the manners and practices of modern youth?

"I can't understand why John won't attend church with us when he delights to listen to radio services," remarked a puzzled mother to me some time ago. "He says the services are dull, but I can't see that they are any brighter when heard through the headphones."

John is a brilliant student, distinguishing

himself at the University. And perhaps his rather exceptional mental activity makes him hypercritical, for he has not yet reached the age when men begin to realize how little the wisest of them know. But there is little doubt that his attitude towards religious



Sir Arthur Yapp is the National Secretary of the Y.M.C.A., and is therefore well qualified to answer, as he does in the accompanying article, the critics who say that radio is exercising a harmful influence on modern youth.

matters is adopted by many young people to-day. Avoiding church attendance instead of delighting in it as in times past, they are far less religious superficially than were their parents at their age.

Whatever the reasons for this change—and they are many and far-reaching—the

freedom of radio reception holds a strong appeal for such folk. When in church, young people who cannot understand the sermon or find it prosy, must at least pretend to listen—a sacrifice to convention from which they derive no benefit. With radio services, however, conditions are very different. Dropping the headphones or switching off the loud-speaker, listeners are at liberty to withdraw their attention at any moment. And, strangely enough, this very sense of freedom does far more to bind the attention than if methods of compulsion were employed.

But, despite the fact that many young men and women shrink from church attendance from a mistaken belief that it is an infringement on their freedom, most of them realize subconsciously the wonderful feeling of brotherhood and unity imparted to those who worship over the wireless. There is an inspiration, an uplift in the knowledge that one is part of a vast unseen congregation, which, far from being confined to the four walls of a church, is limited only by the vast boundaries of space.

Serious thoughts are the natural outcome of a service of this kind, and the thinkers in the ranks of youth are led to seek the great First Cause behind the marvels of the Universe with even greater sincerity than is customary in a church. Questing for deeper and truer knowledge, many a young radio fan has, I feel sure, found a happiness and faith which, reflected in his everyday life, has changed the trend of his whole existence.

Again, radio is unique in the opportunity it affords of hearing questions discussed from many angles. At meetings and public gatherings, each organized to further some particular cause, the other man's point of

(Continued overleaf.)

S

The Cruise of 'The Mousetrap.'

How Oscillators are Tracked.

I HAVE just returned from a hunting expedition in a 'Mousetrap.' Exactly why the most interesting and efficient wireless device I have seen for a long time has been given such a curious nickname I forbore to ask, but if it is because it is an instrument for catching 'squeakers,' it is not inaptly named, as I soon learnt.

It was a dull afternoon when there drew up by the Secretary's Office at the General Post Office, a dark coloured motor-car, which with its neatly curtained small square windows might have been mistaken for a commercial traveller's brougham, except that projecting above the front left-hand corner of the roof was a double wire frame aerial about three feet in diameter. This was the Mousetrap.

A door was opened at the back and I was smuggled inside. Immediately I forgot the London traffic in contemplation of what seemed to be an excellent reproduction of a log cabin. Rolled maps hanging on one side, a submarine-type compass at our feet, a hinged seat on which we swayed with the motion of the car, confirmed the illusion. Most fascinating of all, in the left-hand corner was a wireless direction-finding apparatus. This resembled a large steering wheel of a car, a stout metal pole passing through the centre, mechanically actuating the outside aerial in such a way that as one turned the wheel, the altered direction of the frame was indicated by a pointer on a circular scale graduated in half-degrees.

Operated in conjunction with this apparatus was a three-valve selective wireless receiving-set, which a peep inside revealed to be essentially a Reinartz detector followed by two stages of note magnification.

'Where are we going?' I asked.

'Complaints of oscillation have reached the B.B.C. from — (a certain North-London district)' was the answer 'and' (this in confident tones), 'we are going to unearth the offenders.' The confidence proved to be justified. On the headphones we soon heard a 'howler' around the wavelength of '2LO.' Then followed a few rapid calculations; some adjustments of the aerial; a little deft manipulation of an aerial condenser, geared about 400 to 1, and which seemed to be actually splitting metres; then a few staccato instructions to the driver to take certain turnings, and in a few minutes the car was brought to a standstill with the indicator pointing accusingly at the house beside which the car had stopped.

It is not for me to say what happened next beyond indicating that the occupants of the house were listening to the London programme on a single valve set employing swinging coil reaction, which was too tightly coupled. I was, however, enlightened as to the *modus operandi* of the sleuths. The Post Office campaign, I was assured, is one of education. Most of the offenders, it is found, sin through ignorance, and are only too glad to mend their ways when a friendly official shows them how to listen harmlessly. Here and there the mischief is due to overrunning a small set—say two valves—in order to secure enough volume to operate a large loud speaker. In such cases the set-owner is apt to remark, ruefully, when his set has been re-adjusted, that 'It isn't so loud,' but invariably

promises are forthcoming that he 'won't do it again.'

'What,' I asked, 'happens in the case of a person who deliberately oscillates to show his distaste for a particular broadcast item?'

'We have special instructions for dealing with those people,' was the laconic reply—and I was left wondering!

So uncannily accurate is the apparatus in the Mousetrap that I am assured that not only is it easy to track down an oscillating set, but it is

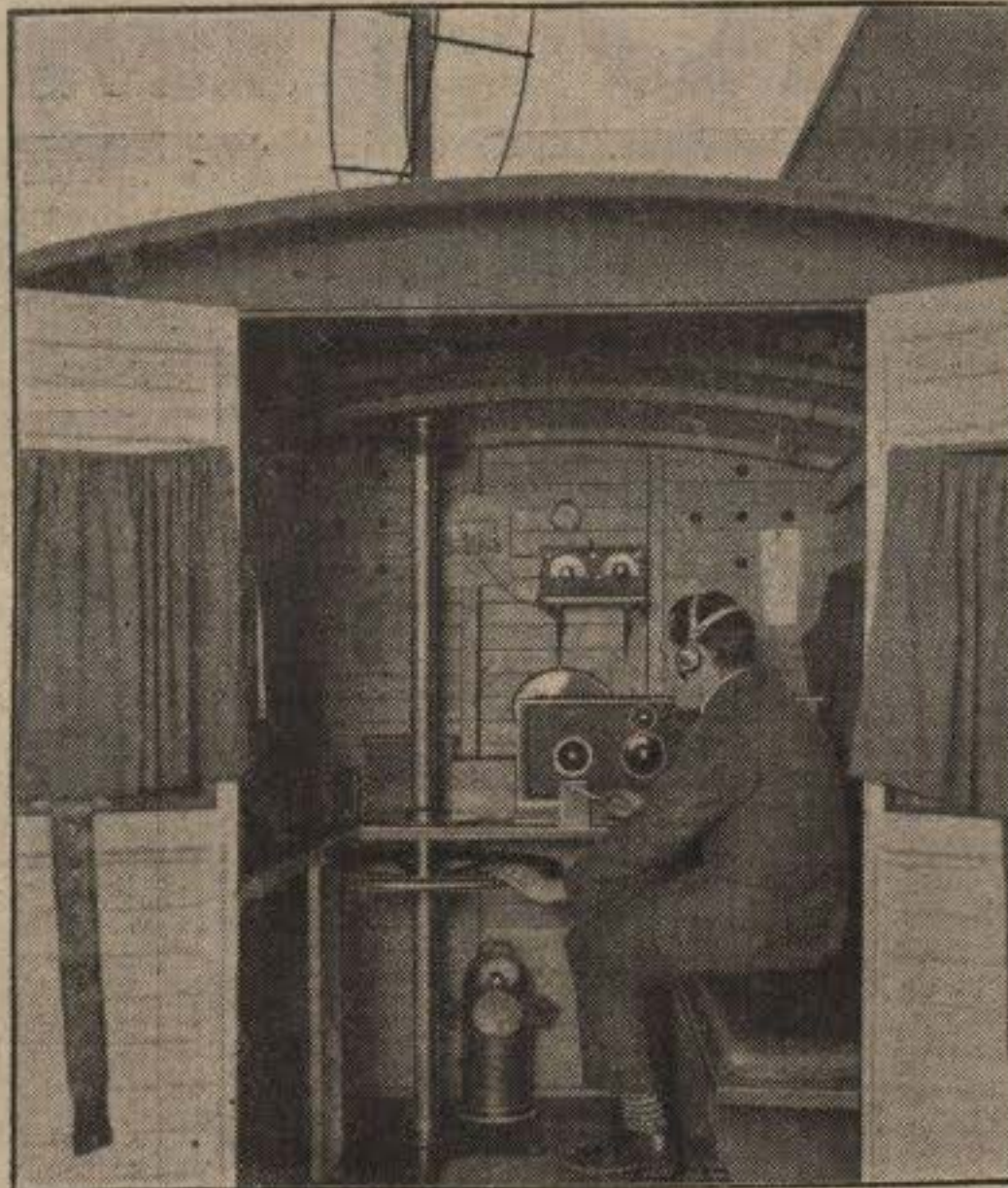

OSCILLATORS, BEWARE!

This picture shows the interior of 'The Mousetrap,' as the author of the accompanying article calls the van now used by the Post Office for the detection of oscillators. Any night it may come stealing along your street, so be careful how you handle your set!

possible to find out from what part of the aerial the oscillations are emanated. Generally, this is from the down-lead. Recently the sleuth hounds embarked on an ambitious jaunt around Oxford Street, experimentally dissecting the waves of '2LO's' three kilowatts, when it was found that the emanations proceeded from the top half of the London Station aerial, an arrangement presumably adopted to meet the complaints of bad receptions in East London when the transmitter was removed from Marconi House.

For the moment the operations of the Mousetrap are confined to London, but so successful have been the results achieved that attention will most likely be devoted to other parts of the country before long. Certain it is that no oscillator can continue undetected in his wrong-doing once the General Post Office engineers have decided to find him.

If you look out of the window and see the Mousetrap with its aerial pointing towards your house, beware!

J. G. GREEN.

The Unseen Congregation.

(Continued from previous page.)

view is seldom accorded a fair hearing. Radio, however, offers a platform which is free to all.

Lectures of this kind are already bearing fruit in the more kindly and tolerant outlook upon life characteristic of the young people of to-day. Proceeding on these lines, I believe that in the future radio will wield a tremendous influence in promoting the sacred cause of unity. After all, the powers of evil are so strong, and the differences of opinion dividing those who fight them comparatively so trifling, that in broadening the outlook of the community to disregard petty distinctions, radio is proving itself a powerful ally to the cause of right.

Although still too early to speak positively, I believe that radio will enhance the depth of religious conviction in the young people of to-day—and especially in the children now growing up. Working as an ally to the cause of right, it may bear an important part in bringing about that friendship and goodwill between man and man for which the whole world longs.

Prose and Verse Competitions.

ON Friday, February 18—the day this paper is published—at 8 p.m., Miss Royde-Smith will broadcast from London and Daventry the first of this new series of competitions. The subject and rules are printed herewith.

The B.B.C. offers a prize of Two Guineas for the best new and original English Sonnet on *A Pair of Old Shoes*.

RULES.

(1) All entries must be written on one side of the paper only, and the name and address of the competitor must appear at the top left-hand corner of each page. Where more than one page is used the pages must be numbered and pinned

together.

(2) Entries need not be typewritten, but if they are written by hand, neatness and legibility will be taken into account in awarding the prize.

(3) Competitors may, if they choose, use a pseudonym or pen-name. This must be written in block letters at the top left-hand corner of each page of the entry.

(4) Entries must reach the B.B.C. office in envelopes marked in the top left-hand corner 'Prose and Verse Competition,' and addressed to the B.B.C., Savoy Hill, London, W.C.2, on and not before Friday, February 25. All entries must be delivered by noon.

(5) A full report of the competition will be broadcast from London and Daventry at 5 p.m. on Friday, March 4, and the prize-winning entry will appear in *The Radio Times* for March 11.

(6) Copies of the report will be sent on receipt of 3d. and a stamped addressed envelope.

(7) The Competition Judge's decision will be final, and no correspondence can be entered into respecting the award of any prize.

London and Daventry News and Notes.

THE tenth of the series of National concerts from the Royal Albert Hall on Thursday, March 17, will include Honegger's Symphonic Psalm, *King David*, which will occupy the whole of the first half of the programme. This will be its first performance in this country and it will be conducted by the composer. *King David* was originally designed for production in the open air and was scored for wind instruments only; but for the National Concert the work has been re-orchestrated for full orchestra. Though by birth a Swiss, Honegger is one of the leading lights in the modern French school, whose music, first heard in England but a few years ago, is now steadily gaining wider recognition. The second part of the programme will be devoted to a new Choral Ballet by the British composer, Holst, and here again the composer will conduct.

George Gershwin, the leading composer of that modern type of music described variously as syncopated music, jazz or symphonic syncopation, whose fame sprang into even greater prominence a little more than a year ago when he gave the first performance at the Savoy Hotel of his *Rhapsody in Blue*, which was broadcast from all stations, has a very long string of 'successes' to his credit. In addition to separate tunes, Gershwin has also written several musical comedies, *Half-Past Eight* and *Our Nell* being among the earlier ones. More recent productions, *Lady Be Good*, *Primrose*, *Tell Me More*, and *Tip Toes* are also his. Half an hour of some of the best-known items from Gershwin's music will be given by the Augmented London Radio Dance Band, under the direction of Mr. Sidney Firman, at 7.45 on Wednesday, March 2, Miss Edith Baker playing some of his tunes at the piano.

The St. David's Day programme on Tuesday, March 1, which, as already stated in *The Radio Times*, is being arranged by Sir Walford Davies, will consist of a concert of traditional and modern Welsh music, and will include some penillion singing by Mr. R. E. Jones (tenor). There will also be a Welsh play, lasting about half an hour, and some harp solos.

The first broadcast in connection with the new B.N.O.C. season will be heard on Wednesday, March 2, when excerpts from the opera, *I Pagliacci*, will be relayed from Manchester. The portions to be broadcast are divided between 8.25 and 9.10 p.m., and 9.20 and 9.40, the intervening ten minutes being reserved for the news bulletin. Between 10 and 11 p.m. the same evening a concert will be given, which will include violin solos by Mr. Albert Sammons, songs by Miss Flora Woodman (soprano)—incidentally this will be Miss Woodman's first appearance at the London Studio—and by Mr. Sinclair Logan (baritone). Mr. Cecil Lewis will give a reading of Oscar Wilde's poems in prose in the same part of the programme.

Part of the proceedings at the Annual Dinner of the London Cornish Association at the Great Central Hotel on Saturday, March 12, is to be broadcast from the Daventry and Plymouth stations between 9.15 and 10.0 p.m.

An hour of chamber music has been arranged to be broadcast from London at 10 p.m. on Monday, March 14, when the programme will be mainly occupied by a famous work—Schubert's *Octet*—played by the Covent Garden Octet, led by Mr. Wynn Reeves, the leader of the National Orchestra at the B.B.C. concerts at the Royal Albert Hall.

A concert of chamber music will be broadcast from Daventry at 9.35 on Tuesday, March 15, the programme consisting of music by Bela Bartok, the Hungarian composer, who will himself conduct. Bartok is one of the outstanding figures in modern music and has a reputation for collecting and arranging the musical folk-lore of his native country. His concert on March 15 will include a number of transcriptions for the piano of old Italian music.

The first performance of two movements from a work by G. Sandow, who was, before the revolution in Russia, a distinguished Professor in the Conservatoire of St. Petersburg, will be included in a symphony concert which Mr. Herbert A. Carruthers, Musical Director of the Glasgow Station, is to conduct in the London Studio on Monday evening March 7, between 9.30 and 11 p.m.

The last hour of the programme on Saturday, March 5, before going over to the Savoy Hotel for dance music, will be occupied by a concert by the J. H. Squire Celeste Octet, whose items will be interspersed with some sociable songs by Mr. John Goss and the Cathedral Male Voice Quartet. Listeners will remember a similar concert on Saturday, January 15, which proved exceedingly popular.

A special programme by The Roosters will be given from Daventry, between 9.45 and 11 p.m., on Monday, February 28, and repeated for London listeners, at 9.35, on Tuesday, March 1.

A request programme of fox-trots, played by the London Radio Dance Band, will occupy half an hour of the programme from 7.45 on Monday, March 7. At 9.15 the same evening listeners will hear another of the series of interviews with famous people by Mr. Cecil Lewis.

The evening service on Sunday, February 27, will be relayed from the Sheffield Cathedral, when the address will be given by the Ven. John Russell Darbyshire, Archdeacon of Sheffield. During the afternoon of Thursday, March 3, the Rev. W. H. Elliott, of Holy Trinity Church, Folkestone, will begin a series of fifteen-minute talks on subjects specially suitable for the Lenten season. These talks will immediately follow the weekly service relayed from Westminster Abbey.

The Boy Scouts' programme at 6.45 p.m. on Thursday, March 3, will take the form of a scene from the Scout play, *The Crusaders*, which will be presented by wolf-cubs, drawn from every pack in the Acton district.

An attractive item in the evening programme on Monday, February 28, will be a talk on 'Worcestershire,' which will be given, first in ordinary King's English, and afterwards repeated in the Worcestershire dialect, by Mr. 'Garge,' a native of that county.



H. R. H.

London and Daventry listeners will have the welcome opportunity on Monday evening next of hearing the voice of the Prince of Wales when he makes one of his famous after-dinner speeches at the Mansion House, in connection with the opening of the British Industries Fair.

Forthcoming variety items:—

MONDAY, FEB. 28.—Ella Retford, in some of her best-known comedy numbers.

THURSDAY, MAR. 3.—Grace Fisher, one of America's most noted musical comedy stars, in some of her successes.

FRIDAY, MAR. 4.—R. A. Roberts, in his *Dick Turpin* sketch, originally arranged to be broadcast on January 18, but postponed owing to the illness of the artist.

Betty Chester: Syncopated numbers.

Alec Cheatrens: French and English light comedy numbers.

SATURDAY, MAR. 12.—Neil Kenyon: Scottish comedian.

London Radio Dance Band.

News From the Provinces.

MANCHESTER.

JUST over a year ago, an innovation was introduced into the Manchester programmes with the performance of a musical drama written by Mr. Leigh Henry, around certain incidents in the life of Mozart. The aim was to portray, in three different episodes, events which led Mozart to compose some of his masterpieces, and to blend music and speech with harmonious effect. The characters appearing include Mozart, Mozart's wife, Sussmayr, his favourite pupil and friend, and Schikaneder, his librettist. On Sunday afternoon, February 27, this programme will be repeated, being relayed to a number of other stations, including Aberdeen, Dundee, Sheffield, Nottingham, Liverpool, and Plymouth.

Students of the Manchester University have for some years established an institution in the life of the city with their 'rag' on Shrove Tuesday. Clothed in weird garments, they descend upon the citizens and collect money for important local medical charities. Last year the magnificent total of over £6,000 was reached, but it is hoped to do even better this year. The Manchester Station has lent its help to this noble effort on more than one occasion, and on Monday evening, February 28, is again giving up its studio to the students, who are presenting a novel 'Rag' programme, in which they will introduce 'after-dinner speeches of the Geoplanarian Society,' 'music to suit various heights of brow,' and a 'short destructive address by somebody who doesn't matter.'

The Duke of Killcrankie, by Robert Marshall, is the next long play to be given from the Manchester Station, Monday, February 28, at 9.30 p.m., being the date and time of its presentation. The story centres on the efforts of the Duke of Killcrankie to induce the Lady Henrietta Addison to marry him, and contains many intensely amusing situations. As usual, booklets will be published containing the story of the play and a number of illustrations.

The Vaudeville programme on Wednesday, March 2, promises to be highly entertaining. Among the artists are Miss Elspeth Douglas-Reid, in her original character sketches; Mr. Verdi Popple, who is to present character studies of famous actors of bygone days; and Mr. Andrew McAllister, the new-style comedian, in addition to other artists who have already become familiar to listeners in these programmes.

SHEFFIELD.

SPEECHES by Mr. J. H. Thomas, M.P., and Mr. Arthur Neal, on the occasion of the Annual Dinner of the Sheffield and District Cambrian Society, will be relayed from the Grand Hotel, Sheffield, on the eve of St. David's Day, Monday, February 28. The speeches will last from 8.15 to 9.30 p.m., after which a concert by Welsh singers will also be broadcast from the Grand Hotel.

PLYMOUTH.

ANOTHER 'Round the Stations' programme is to be broadcast at 7.45 p.m. on Tuesday, March 1. On the following evening a short concert of musical comedy songs will be given by Mr. Harold Kimberley (baritone) and the Station Orchestra, under the direction of Miss Winifred Grant.

A recital of Red Indian songs, with notes on the nature and significance of this music, will be given by Miss Dorothea Johnston on Friday, March 4.

CARDIFF.

A QUARTER of a million persons are employed in the coal mining industry of Wales, and normally the usual output exceeds fifty million tons. Out of every ton of coal produced in the world, one hundredweight represents the proportion of the Principality. In the light of these facts, the programme from Cardiff on Wednesday, March 9, entitled 'Welsh Miners' Night,' should be of national interest. Welsh miners are well known for their musical qualities, and they invariably sing at their work in the mine. One of the items will be the rendering by Huw Menai of some of his poems. This Welsh miner-poet has worked in the coal mines of the Rhondda Valley since he was fifteen years of age. A Male Voice Choir from a mining valley will also take part.

At the request of many listeners, a repeat performance of the play, *The Prince of Peace*, an incident in the life of St. David, is being given on March 6, the Sunday following St. David's Day.

Those who heard the broadcast of *Samson* by the Newport Choral Society on December 9 will look forward to another programme by the same Society on Thursday, March 10, when Elgar's *The Apostles* will be given for the first time in Newport. Mr. Herbert Heyner, a great favourite with Welsh listeners, will be one of the soloists, and the orchestra and chorus number three hundred. The Station Orchestra will take part.

The programme on Friday, March 11, is entitled 'A Bristol Night,' all the artists coming from that city. Mr. Frank Thomas, well known to our listeners as leader of the Station Trio, will play and The Harmonic Four Glee Singers will also be heard.

LEEDS-BRADFORD.

LOVERS of the Brontës will be interested in the talk to be given on Thursday, March 3, when Mr. Percy Robinson, the well-known Yorkshire authority, will give a talk on Oakwell Hall. Oakwell Hall is the 'Fieldhead,' which forms the setting of Charlotte Brontë's novel, *Shirley*, and is one of the most interesting and picturesque relics of the Elizabethan period in Yorkshire, having been built in 1583. This noble mansion is now threatened with abolition and transportation; wealthy Americans have cast covetous eyes upon it, with a view to adding it to their growing collection of old English dwellings.

A programme on Monday, February 28, will be provided by the Huddersfield Vocal Union, and Prize Winners of the Halifax Competitive Musical Festival.

LIVERPOOL.

THE first part of the programme from the Liverpool Station on Wednesday, March 9, will include a lecture-recital by Miss Dorothea Johnston, who will talk about the songs of the Red Indians and will sing several examples. Her recital will be preceded by an orchestral arrangement of Four American Indian Songs by Cadman, and the Station Orchestra will also play the suite *Cobweb Castle* by Liza Lehmann. Subsequently, as already announced in *The Radio Times*, a radio version of Ibsen's *Peer Gynt*, prepared by Edward P. Genn, and performed by the Liverpool Radio Players, under his direction, will be relayed from the Liverpool Studio to London, Daventry, and other stations. Mr. William Armstrong, Director of the Liverpool Playhouse Company, will play the part of 'Peer Gynt,' and Miss Irene Rooke the part of 'Aase.'

BOURNEMOUTH.

PORTSMOUTH artists are to take part in a programme called 'Portsmouth Talent' on Wednesday, March 2. The soloist, Miss Edythe Kinch, is already well known to listeners, though this will be the first appearance, as far as the majority of listeners are concerned, of the Portsmouth City Glee Singers, who are drawn from two of the principal choirs in that city.

'The Land of the Golden Fleece—A Journey through Georgia' is the title of a travel talk to be given by Colonel Liddell on Tuesday, March 1. The Georgia which Colonel Liddell visited a few years before the War for the purpose of surveying a railway, is not the American State of that name, but the ancient kingdom lying South of the Caucasus Mountains, which has for many years formed part of the territory of Russia.

A short Recital of Lieder is to be given by Miss Eather Coleman on Monday, February 28, in a concert devoted to the works of Schubert and Schumann. Another programme which will appeal to music lovers is the half-hour of Chamber Music to be given on Tuesday, March 1, by the Premier Woodwind Quintet. The concert will be preceded by a variety programme by Tommy Handley and Florence Oldham, of radio revue fame.

Later on the same evening, there is to be a St. David's Day programme, a special feature of which will be the singing by the Bournemouth Male Voice Party of Welsh airs and songs by Welsh composers. Of these, the greater part will be given in English.

BIRMINGHAM.

THE last of the series of four concerts to be held in the Birmingham and Midland Institute takes place on Saturday, March 5. The programme is largely composed of popular orchestral items mentioned by listeners in correspondence. The orchestra will be conducted by Mr. Joseph Lewis, who will also take charge of the Community Singing, with the assistance of Mr. Harold Casey (baritone). Midway in the programme will be heard Grieg's *Bergliot*, a declamation with orchestra, in which the speaker is Miss Gladys Ward. Prices of admission are 1s. 2d. and 2s. 4d.

The Principal of the University of Birmingham, Mr. C. Grant Robertson, C.V.O., is to give six talks, in which he will continue the series of 'Empire-Builders' which he delivered in 1925. The new series takes place on Wednesdays, from March 2 to April 6, inclusive, and will in turn deal with Raleigh, Marlborough, Warren Hastings, Stamford Raffles, Lord Durham (of the famous report) and lastly, Livingstone.

The speaker at the midday service, relayed from St. Martin's, the Parish Church of Birmingham, on Thursday, March 3, will be the Rev. G. Studdert Kennedy, equally well or better known to many as 'Woodbine Willie.'

Two plays will be broadcast in the week beginning Monday, February 28. The first, on the Wednesday, by the Station Players, is a Jacobite play entitled 'Sword or Scabbard,' by Kate S. Riley and describes scenes in Birmingham during the Scottish Rebellion of 1745; and the second on March 4 which describes an episode of the Franco-Prussian War, which will be presented by the London Radio Repertory Players.

The Listener's Point of View.

Does Realism Get Across? By Sydney A. Moseley.

THOSE who have followed the efforts of the B.B.C. to transmit realistic sounds as an aid to the presentation of radio drama will unhesitatingly applaud and encourage these efforts. No one would have the temerity to suggest that these experiments should be curtailed or discontinued.

Yet I find myself often wondering whether these experiments are, in fact, successful or ever can be successful. So far as I am concerned, the results have appealed more to my interest than to my imagination.

Let me give one or two instances. There was a transmission some time ago from a quayside, when we were asked to imagine the arrival or departure of a party of Continental passengers. This, no doubt, must have given spur to the imagination of those listeners who live in the wilds. Most of us, however, do not live in the backwoods, we live in towns and cities and are therefore well accustomed to noise, hustle and bustle, and naturally do our best to escape from the hurly-burly.

The effect of these transmissions of the noises of the crowd seems to me to be spoilt by the noise itself that is transmitted. I always find it difficult on these occasions to make head or tail of any particular part of what is being broadcast.

This criticism applies to the realistic transmission some time ago of a party of travellers who were supposed to be pursued by wolves across the Steppes of Russia. The music was excellent and the atmosphere at the beginning was convincing enough.

THE whole thing promised to develop into a thrilling climax. But, according to my view, the whole effect was spoilt by the too realistic shrieking of the lady when she found, to her horror, that the wolves were after her. An excellent actress, I should say, but not for the microphone—at any rate, not when she is being pursued by wolves!

Another and more common instance where

in to the point of rendering inaudible certain essential parts of the play or story.

Again, the realism employed in broadcasting a storm during a recent evening programme gave me little enjoyment and much headache. Continual sheet lightning and peals of tin thunder cut out much of the dialogue on this occasion—although I confess that the little I managed to hear somewhat reconciled me to my loss.

So much for the case against realism. What is there to be said on the other side? There can, of course, be no doubt that carefully applied realism can become a successful and important part of the broadcast programmes. For instance, I remember the broadcasting of a scene in a play about the flooding of a coal mine. That was very well done. It offered a fine scope for realism which was successfully carried out, but not in such a way as to interfere with the 'business' part of the play. We heard the intruding water and yet we lost

none of the words of the imprisoned visitors. To sum up, I suggest that the B.B.C. should confine the transmission of realism to the less sound-confusing phases, and that those who attend to these matters should always remember Lewis Carroll's advice: 'Take care of the sense and the sounds will take care of themselves.' The nightingale rather than Niagara!

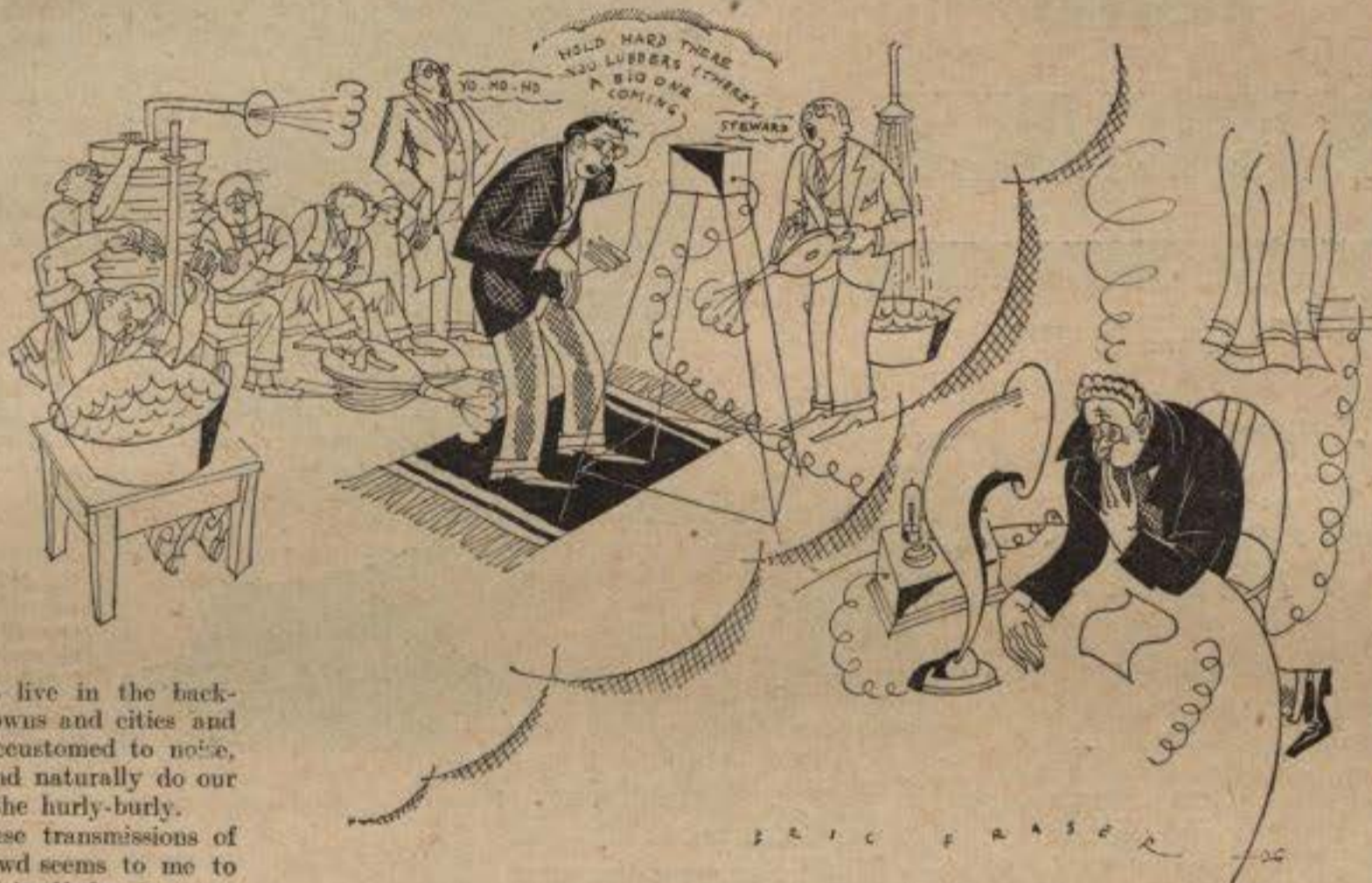

realism is apt to be overdone in the broadcasting studio is in the simulation of the lapping of the waves of the sea. The production of the sound of the sea across the ether is a fine achievement, and on more than one occasion I have enjoyed listening to the lapping of the water on a shingly beach, but, after a while, one finds that it becomes rather a nuisance, especially when it is persisted

The Problem of the Concert Industry.

By M. A. Randall.

THE news that in the near future London's famous Queen's Hall may become a cinema, and the reasons stated by the present lessees for such a change, have given everybody who cares about the musical prospects of this country much food for thought. The present crisis is not entirely unexpected by those who know something about musical conditions in London, and have seen them going from bad to worse for some time past. But those who lay all the blame at the door of the B.B.C. do not get at the root of the matter.

Certain people affect to regard the B.B.C.'s low-priced concerts as unfair competition with private enterprise, but if low-priced concerts really are the cause of the present crisis, the critics of broadcasting must look elsewhere than to the B.B.C. for the culprits.

It is, of course, notorious that ever since the B.B.C. came into existence a certain section of the musical world has been constantly attacking it, but is it not rather strange that the people who really are, doubtless quite innocently, doing

harm to the money-making side of music, should continue their activities without protest from anyone; on the contrary, they are constantly receiving laudatory paragraphs in the musical papers. I refer to those kindly people who, in their desire to spread musical appreciation among the public, give regular first-rate concerts entirely free.

Why do not the critics of the B.B.C. complain, for example, about the League of Arts Concerts that are held every Saturday afternoon at the Victoria and Albert Museum, South Kensington? They are quite free, but each member of the audience is requested as a favour to pay sixpence for a programme so as to help to cover the cost. Cannot this be described as unfair competition with the Queen's Hall Saturday afternoon concerts? The Sunday afternoon concerts at the Queen's Hall have been stopped—it is said through lack of public support, but no one seems to have thought of blaming the free Sunday concerts held at the Working Men's College, South Place, and at the People's Palace.

There is, perhaps, too much charity in the musical world. In their desire that the general public should hear good music many well-meaning people are willing to give it away for nothing. It is in fact quite possible for anyone to hear as much music in London as they have time for without paying a penny for it. In this respect even the musical colleges are not free from blame. The Royal College of Music advertise their concerts and "cordially invite the public," without even bothering them to apply for tickets.

Where is the theatrical manager who is so desirous of spreading appreciation of Shakespeare and the classics that he is willing to give free shows for the purpose? No one but a musician would ever think of adopting such a self-destroying policy. If music is to be regarded solely as a money-making business there should, of course, be no free music at all; in any case it is absurdly unfair to attack the B.B.C. for giving cheap concerts whilst at the same time applauding Music's charitable institutions.

CAV

MUSICOLA

LOUD SPEAKER

Complete with terminal leads.
(2,000 ohms.)

£2.2.0

Price in U.K.

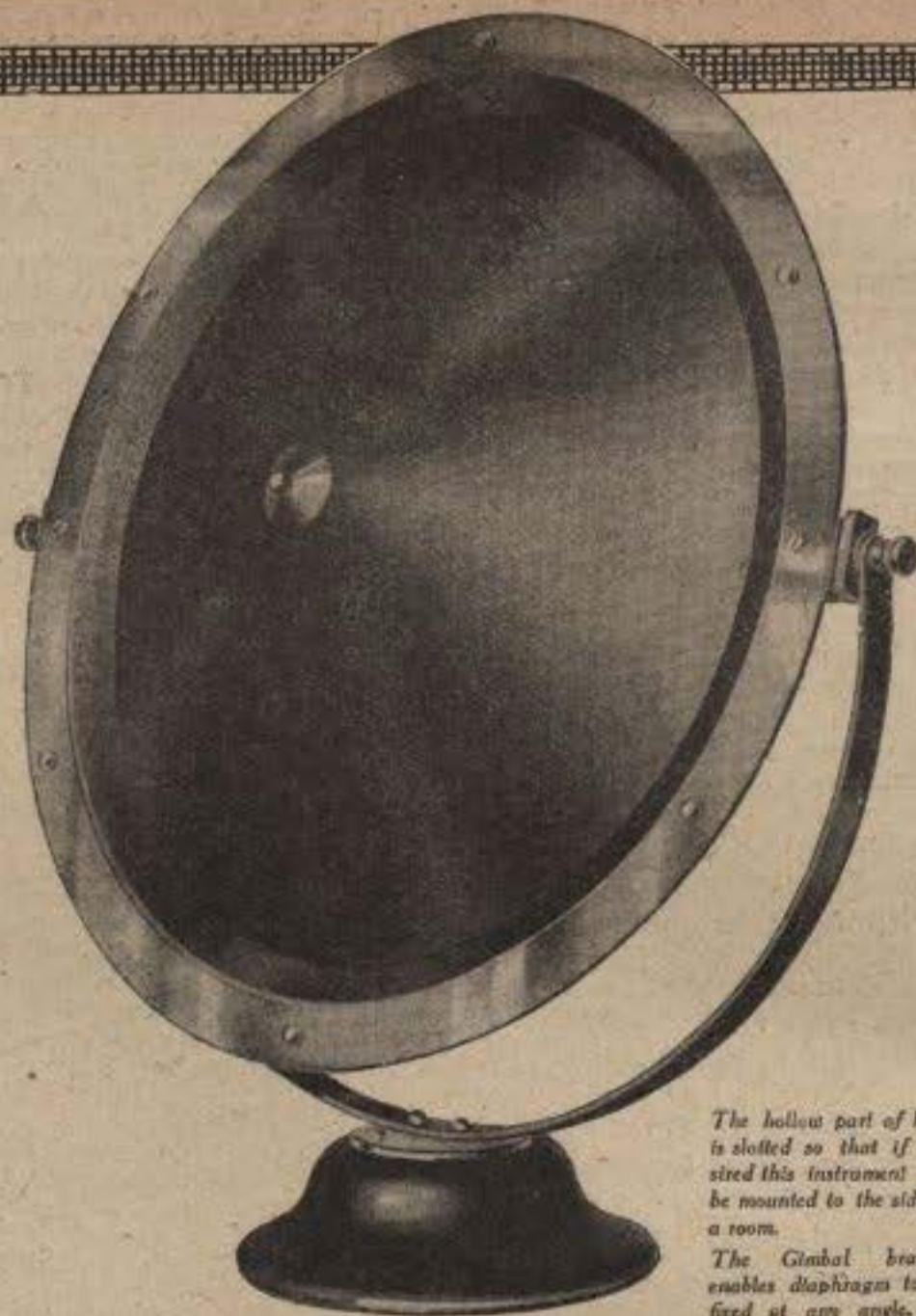

The hollow part of base is slotted so that if desired this instrument can be mounted to the side of a room.
The Global bracket enables diaphragm to be fixed at any angle.

Strikes the right note



FIRST efforts are seldom crowned with success. Only by untiring determination in the process of eliminations and additions is perfection evolved.

Loud Speaker designs have hovered in many directions to achieve perfection, until the advent of the MUSICOLA which "strikes the right note," not in performance alone, but also in price and appearance.

With a magnetic unit having a full size movement, and a scientifically designed vibrating cone, the best features of the ordinary cone type speaker on music and the horn type on speech are here embodied in one instrument. It has a mellow tone true to every audible frequency of sound.

The unique shape and antique brown leather finish has an engaging appearance, and its low price, based on large productions, puts this high grade article within the reach of everyone.

Write for copy of C.A.V. Illustrated Radio catalogue.

Telephone: CHISWICK 3601
(Private Branch Exchange)

CAVandervell & Co., Ltd.
ACTON, LONDON, W. 3.

Telegrams:
"VANERIA-ACT-LONDON"

SALES DEPOTS:

BELFAST 3-5 Calvin Street.
Grams: "Seready, Belfast." Phone: Belfast 7017.

BIRMINGHAM 61, King Street.
Grams: "Lucas, Birmingham." Phone: Northern 2201.

BRISTOL 7 and 25, Temple Street.
Grams: "Kingly, Bristol." Phone: Bristol 6661.

DUBLIN Taylor Bros., 41, Middle Abbey St.
Grams: "Autobite, Dublin." Phone: 415.

GLASGOW 227-229, St. George's Road.
Grams: "Lucas, Glasgow." Phone: Douglas 2075-4.

LEEDS 117, Park Lane.
Grams: "Rotax, Leeds." Phone: Leeds 2058.

LONDON 90, High St., Camden Town, N.W. 1.
Phone: North 1149.

MANCHESTER 221/3 and 277, Deansgate.
Grams: "Lancaster, Manchester." Phone: Centre 6919.

NEWCASTLE-ON-TYNE 68, St. Mary's Place.
Grams: "Mastell, Newcastle-on-Tyne." Phone: City 366.

WEST END SALES DEPOT:

LONDON 224, Shaftesbury Avenue, W.C.2.
Grams: "Guidepost, Westcent, London." Phone: Regent 4221 (3 lines).

OBTAINABLE FROM ALL RADIO SUPPLIERS, C.A.V. SERVICE AGENTS, OR ANY DEPOT ABOVE.

C.A.V. RADIO ACCUMULATORS

Model "H.F. 3."



C.A.V. H.T. Accumulators are a decided advance as compared with dry batteries. When dry batteries are down they are done. Frequent renewals make them more expensive. The C.A.V. H.T. will last for years. They give bigger volume and are silent in operation.

Supplied fully charged and with distilled water filler.
60-Volts. - 60/-
30 and 90-volts. at pro rata prices.

"ACTON" CELLULOSE L.T. RANGE.



Offered at prices which are strictly competitive with the lowest on the market, the "Acton" range represents remarkable value.

Type	Volts.	Amp. Hrs.	Actual Price
2A. 40	2	20	11/-
2A. 60	2	30	13/6
2A. 80	2	40	16/-
2A. 100	2	50	18/6
2A. 120	2	60	21/-

4 and 6-volts at pro rata prices.

Broadcasting Football from the Ground.

AS an eavesdropper at the recent match between England and Wales at Twickenham, I was perhaps more interested in the broadcasting of the running commentary than I was in the play upon the field. And I noticed that a large number of other people in the neighbourhood of the Announcers' cabin divided their attention between the game and the broadcasting with swift, 'rubberneck' turnings which reminded me of the crowd at a fast tennis match when everybody tries to keep his eyes upon the ball.

The cabin from which the broadcast was made at Twickenham was set up on a temporary platform supported by scaffold poles, and looked a fragile affair, until one cast an eye over the expert trussing and roping. In shape and size it was not unlike a 'Punch and Judy' theatre, with a front window hinged from the top. It was evidently not built to the scale of the Announcers; nevertheless, three men rather on the large size manœuvred themselves into position, and the door was somehow persuaded to close upon them. If they had not discarded their overcoats, however, they would have needed a large-size shoehorn to fit themselves in.

The enthusiasm of the crowd was thrilling enough, but the keenness of the B.B.C. men absorbed my attention. They were plainly alive to the importance of their experiment. Their team-work was splendid.

Long before the players appeared on the field we had heard a preliminary test, both Announcers reading something from a newspaper about the fashions prevailing in Paris, which tickled the near-by crowd exceedingly. From the power-wagon, twenty feet below, came the word, relayed *viva voce* by the string of helpers, that everything was O.K.

There was apparently some anxiety on the part of the B.B.C. officials on the spot lest the vast crowd should overflow its boundaries and endanger the lofty cabin and the success of the experiment, and although the waves of excited people, who as

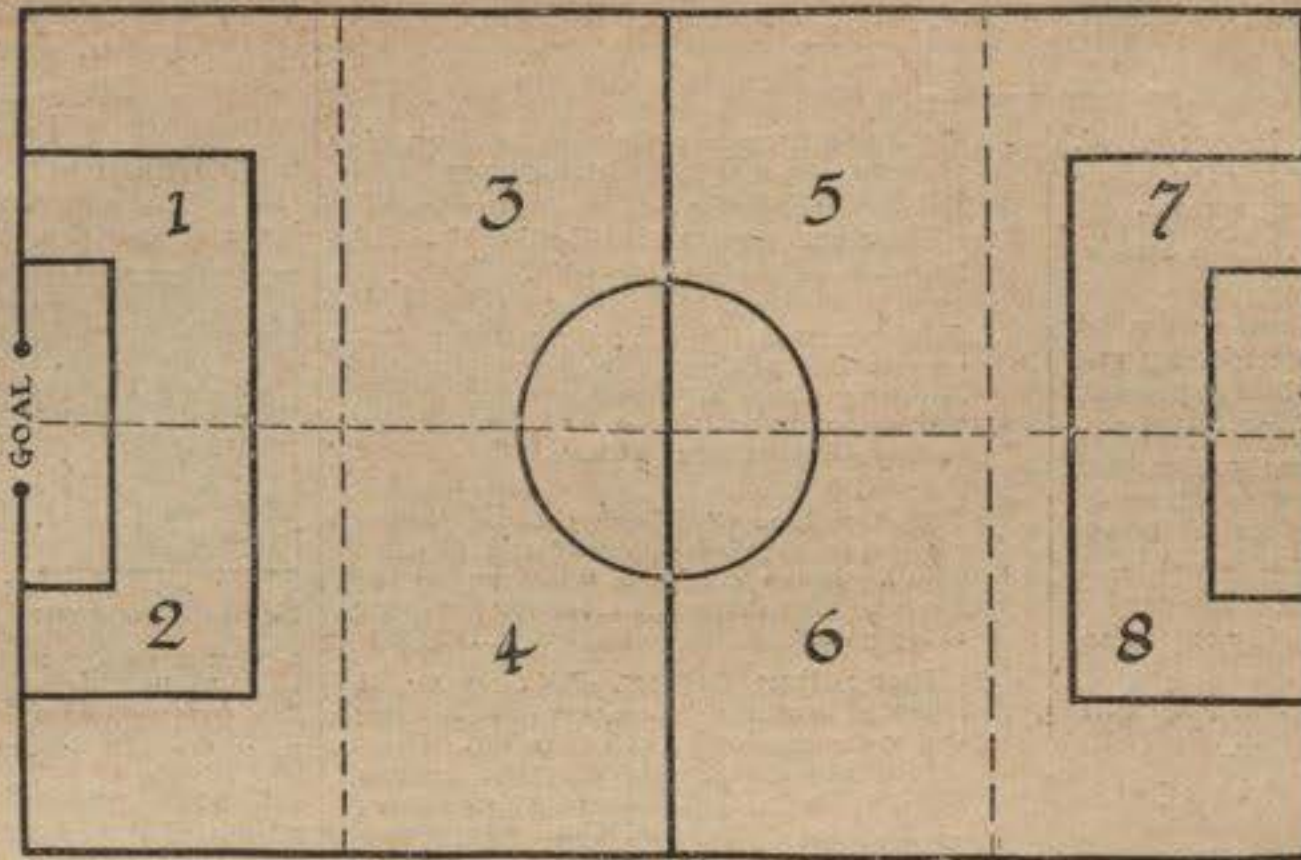

Use this plan when you listen to Association games.



As the Announcer sees it.

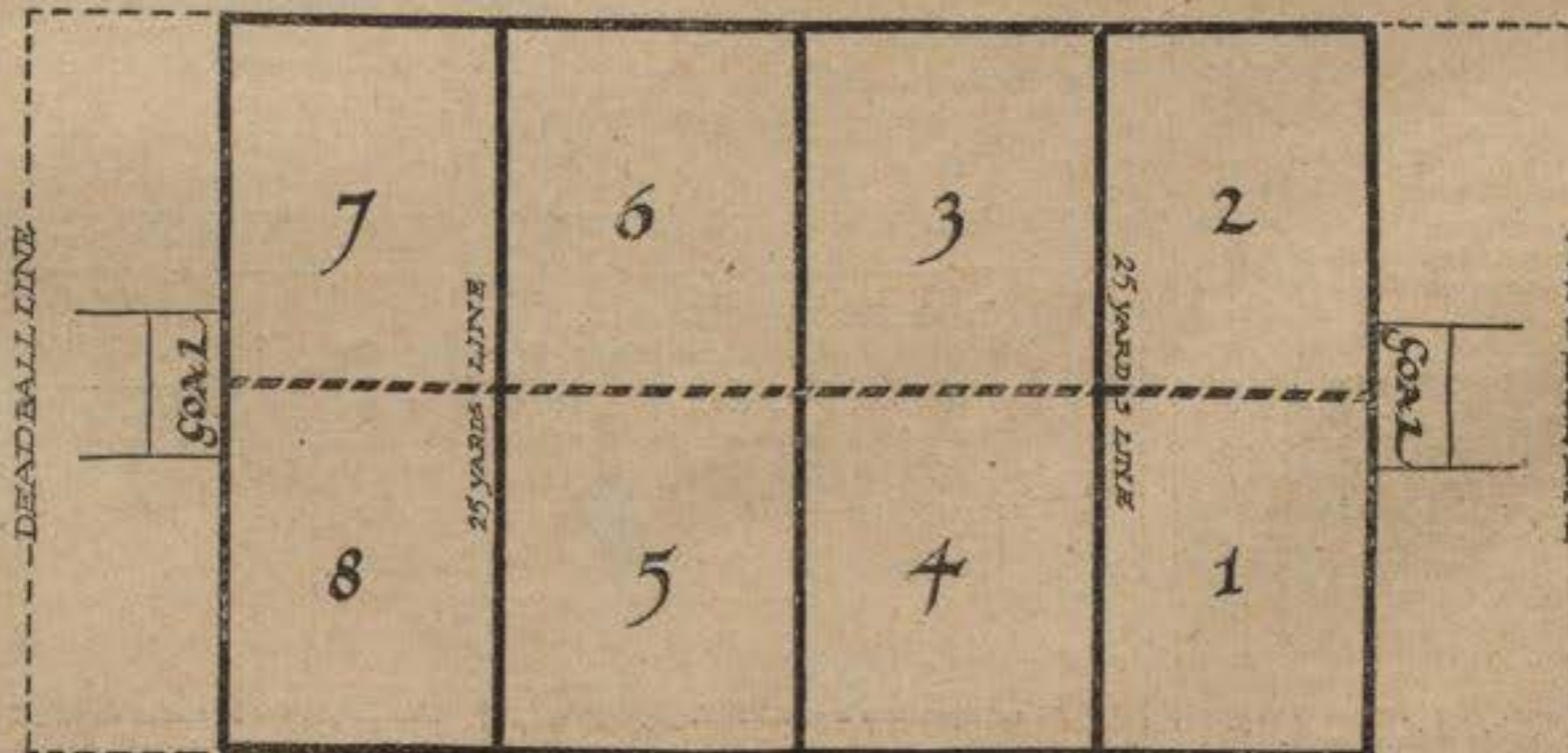

This is the plan for Rugger fans.

the match proceeded were worked up to more and more excitement, washed right up to the box, there was a sturdy breakwater of young men, who looked as if they could keep the multitude at bay.

Presently the fatal moment arrived when the signal, 'Coming over!' was given, and the two Announcers, looking a trifle awestruck I thought, were pitched headlong into the sea of silence to sink or swim. In a moment there was excitement enough. The cabin window became steamed over. Handkerchiefs were hastily applied inside and out, and we could see the An-

nouncers dodging sideways to catch glimpses of the field. But they kept up a steady flow of description. Then somebody opened the window wide, and a rapid fire of talk came over our heads. There was a moment's concern lest the cheering and cries of the crowd would spoil the show, but presently there came up from the engineers in the motor below an emphatic assurance that everything was going swimmingly and that the Announcers could be plainly heard as well as the cheering of the crowd.

Now the broadcast of the game was in full cry, and written all over the faces of the B.B.C. men was the joy of a job well handled.

Presently we who were in the crowd near by got used to the voices behind us, and gave all our attention to the match. There must have been thrills in Bristol upon hearing of Corbett's exploits, and every town and fire-side connected with the players throughout the country must have got their fill of excitement. One felt glad that millions were

listening, and that they were hearing the organ-like swell of the cheering, which must have told the story almost as clearly as it was given by the B.B.C. Announcers.

This account of the first experiment may perhaps help listeners to football broadcasts to enter into the feelings of 'the man in the hut' when the first whistle blows.

WHY BE POOR?

When You Can So Easily Double Your Mental Output.

SOMEONE has said that the human mind, being a product of the struggle for existence, is essentially a food-seeking system.

That is to say, it is a system which enables you to earn your living.

Of course, it is more than that, or can be made more than that, by proper training and education. But essentially it is that at present.

It follows, therefore, that unless you are fully utilising your mental system you are not earning as good a living as otherwise you would do. And there are thousands of people to-day who are only utilising one-quarter or one-half of their mental powers.

Consequently—it is no use making any bones about it—they are Poor.

Poverty And Poor Thinking.

In fact Poverty in thousands of cases (not in all) is due to Poor Thinking.

The problem, therefore—"yours, mine, everyone's," as Browning said—is *how to utilise the whole of one's mental powers.*

That is the problem which Pelmanism solves.

Pelmanism trains your mind. It trains it scientifically and on the right lines. It develops powers and faculties which you have allowed to fall into disuse. It teaches you not to be Forgetful, not to be Self-Doubtful, not to be Timid or Irresolute, not to allow yourself to fall into the rut of Routine.

And, on the other hand, it develops your Initiative and your Will Power, it enables you to cultivate the art of Concentration, it sharpens your powers of Observation, it gives you Self-Confidence and Resourcefulness, it doubles your Efficiency and consequently increases your Earning Power.

People Who Are Securing Promotion.

That is why so many people write to say that as a result of taking up Pelmanism they have doubled their incomes and secured promotion to higher positions in life.

A Business Man writes: "It is with feelings of great pleasure I am writing to inform you that I have been promoted to the position of General Manager. When I took up the Pelman Course I knew I had the abilities to succeed, but truly you showed me how." (F.32,216.)

A Clerk writes: "Six months after studying your course my salary was doubled. I realise more and more that there is a harvest to be reaped through Pelmanism." (D.23,091.)

A Fitter writes: "Since I have been a Pelmanist I have had two promotions, which, I think, is mostly due to your very excellent advice and instructions." (P.27,454.)

A Civil Engineer writes: "I am considerably more observant, better in health and can concentrate on things I dislike but have to do. My memory for names is improving; I can visualise easily." (G.32,075.)

A Shop Assistant writes: "Allow me to pay my little tribute to Pelmanism. I had an increase last week in my salary, and a very good one at that. My sales have trebled and are still 'looking upwards.' It has acted like magic in my case. A few months ago I lacked Self-Confidence; now I feel capable of 'tackling' all comers. To repeat another student's statement, 'Pelmanism was the best investment I ever made.' Please accept my gratitude." (P.31,238.)

A Telegraphist reports that he has been able to secure an appointment simply and solely through Pelmanism. (B.26,743.)

An Electrician reports that he has "already gained a substantial rise in wages." (S.27,470.)

A Printer reports the following results: "Increased Self-Confidence; Optimism; Improved Memory; Ease of Concentration; Clearer and more Active Ideas and Imagination; Keener Observation; Initiative." (W.32,045.)

A Doctor writes: "I have changed from an easy-going, take-it-for-granted sort to a man with a purpose and joy of achievement; and I can see that others are observing the change to my gain." (K.30,108.)

An Engine-Room Artificer, R.N., reports the following benefits: "Recovery of Self-Respect due to the eradication of bad habits. Return of Efficient Memory resulting in increased Self-Confidence, Eradication of such weaknesses as Self-Consciousness and Unnecessary Fears." (K.32,197.)

A Clerk writes: "I have received two substantial increases of salary in six months and have very bright prospects for the future." (L.24,278.)

A Mining Engineer writes: "Pelmanism has benefited me considerably. I have just got a post with £20 a month greater salary than I have ever had, namely, £60 a month and maintenance. I have now got absolute confidence in myself. I was able to impress my new employer that I was the man he needed." (L.26,265.)

A Pharmacist writes: "I have benefited inestimably from this Course, not in a startling way but in many small ways which would be difficult to define. I've always had a purpose, but Pelmanism has made it clear that this purpose must be kept alive and healthy to be of any good. I see life now as a thing to be enjoyed, not tolerated; my outlook is broader and kinder. The cost of this Course is nothing compared with the value given in return." (R.32,356.)

Further examples are given in a little book entitled "The Efficient Mind," which also contains a full description of the newly revised Pelman Course and shows you how you can enrol for a course of Pelmanism on specially convenient terms. A copy of this most interesting book will be sent, gratis and post free, to everyone who writes (or calls) for it to-day to the Pelman Institute, 95, Pelman House, Bloomsbury Street, London, W.C.1.

Readers who can call at the Institute will be cordially welcomed. The Chief Consultant will be delighted to have a talk with them, and no fee will be charged for his advice.

DO YOURSELF A GOOD TURN BY USING THIS FREE COUPON TO-DAY.

To the PELMAN INSTITUTE,
95, Pelman House, Bloomsbury Street, London, W.C.1.

Sir,—Please send me, gratis and post free, a copy of "THE EFFICIENT MIND" with full particulars showing how I can enrol for the revised Pelman Course on the most convenient terms.

Name

Address

All correspondence is confidential.

This Coupon can be sent in an OPEN envelope for id.

Overseas Branches: PARIS: 35, Rue Boissy d'Anglas. NEW YORK: 19, West 44th Street. MELBOURNE: 308, Flinders Lane. DURBAN: Natal Bank Chambers. DELHI: 10, Alipore Road.

THE NEW PSYCHOLOGY.

"A Plan Whereby We Can Make The Best of Our Qualities," says Sir J. Foster Fraser.

"PELMANISM," writes Sir John Foster Fraser, the well-known author, traveller, and special correspondent, "is genuinely scientific. There are no technicalities. You learn to know yourself; you train the mind on particular matters if you like, but all your mentality is braced. You apply your psychological knowledge to your work and you are surprised at the consequence.



Sir John Foster Fraser

"It will not make the dun-derhead into a statesman, but it will and does provide a plan whereby we can make the best of our qualities."

Revised Course Now Ready.

The newly revised Pelman Course places the results of the latest discoveries in Psychology at the service of every reader. It is based on the unique experience gained by the Pelman Institute in the course of training the minds of over 500,000 people. There is nothing abstruse or difficult about it. It involves no brain-racking study. It is as interesting as a game of chess or an exciting novel and far more profitable in its results. It increases your Mental Energy. It strengthens your Will Power. It banishes Timidity. It gives you Courage, Initiative, Forcefulness, and Determination. It drives away Depression. It enables you to take an Optimistic outlook on life. After an evening with the "Little Grey Books" you will retire to rest full of creative ideas for the following day. That doesn't mean that you will not sleep. Your mind will be perfectly tranquil. There will be no worry or anxiety. But in the morning those creative ideas will still be with you, and with the help of Pelmanism you will proceed during the day to carry them through.

Readers who are interested will find a full description of the revised Pelman Course in a little book entitled "The Efficient Mind." This book can be obtained free of cost by applying for it to-day. Write to the Pelman Institute, 95, Pelman House, Bloomsbury Street, London, W.C.1, and the book will be sent to you by return gratis and post free.



Write for a copy of this Book TO-DAY

Do yourself a good turn by writing or calling for this Free Book to-day.

PROGRAMMES FOR SUNDAY (February 20)

The reproduction of these Copyright Programmes is strictly reserved.

2LO LONDON. 361.4 M.

3.30 THE WIRELESS MILITARY BAND, conducted by Lieut. B. WALTON O'DONNELL, R.M.

Overture, 'Le Duc d'Orlonne' *Auber*
 Suite from 'The Crown of India' *Elgar*
 Introduction; Dance of the Nautch Girls;
 Menuetto; Warriors' Dance; Intermezzo;
 March of the Mogul Emperors

HAROLD WILLIAMS (Baritone)

Limehouse *Walford Hyden*
 Hiawatha's Farewell ('Hiawatha')
 *Coleridge-Taylor*

West Country Lad ('Tom Jones')

..... *Edward German*

BAND

Three Caucasian Sketches *Ippolitov-Ivanov*
 In the Gorge; In the Bazaar; Procession of
 the Sirdar

Short Recital by SOLITO DE SOLIS

(Solo Pianoforte)

Evening (Des Abends) *Schumann*
 Love Song (Liebeslied)

..... *Kreisler, arr. Rachmaninov*

Dance of Olaf *Pick-Mangiagalli*
 Love's Dream (Liebestraum) *Liszt*

Etude, Op. 10, No. 4) *Chopin*
 Valse in D Flat)

BAND

Largo and Scherzo from 'The New World'
 Symphony *Dvorak*
 Entry of the Gods into Valhalla *Wagner*

HAROLD WILLIAMS

The Pretty Creature *arr. Lane Wilson*

Trade Winds *Frederick Keel*

Onaway, Awake, Beloved *Frederic Cowen*

BAND

Czardas ('Der Geist des Woiwoden') *Grossman*

5.15 TALES FROM THE OLD TESTAMENT—(V)
 Joseph's Dream (Genesis, xxxvii. and xxxix.,
 1-6)

THIS is another of the famous Bible stories that so many of us learnt as children. It tells how Joseph was the favourite son of his father Jacob, so that his brothers grew jealous of him, and their jealousy was increased by Joseph's dream of the sheaves of corn, so that they sold him to the Ishmaelites. Then comes the incident of the coat of many colours, which they dabbled in the blood of a kid, and showed to Jacob as proof of their story that Joseph had been killed by an evil beast.

5.30-6.0 CHILDREN'S SERVICE

Conducted by the Rev. Canon C. S. WOODWARD
 Relayed from St. John's Church, Smith Square

SERVICES designed expressly for children are one of the happiest features of the Sunday programmes, and Canon Woodward is a most appropriate person to conduct them, as all who have read his books, 'Stories Told to the Seamps' and 'Jesus Amongst the Children,' will agree.

8.0 RELIGIOUS SERVICE

CONDUCTED IN THE STUDIO BY
 THE SALVATION ARMY

Song, 'O Boundless Salvation' (Words by the
 Founder of the Salvation Army)

Prayer will be offered by Major KATE LUMMUS
 (Assistant Secretary for Candidates)

Meditation on the Hymn, 'When I Survey the
 Wondrous Cross' (Arranged by Lieut.-Col.
 Goldsmith)

'Rockingham' by The International Staff Band

Song, 'Come, Ye Disconsolate,' sung by selected
 members of the International Headquarters'
 Songster Brigade and the Salvation Singers

ADDRESS BY GENERAL BOOTH

Solo, 'The Rugged Cross,' Ensign L. Taylor Hunt
 A Personal Testimony

Song, 'Jesus, see me at Thy Feet' (Words and
 Music by Lieut.-Col. Slater)

Appeal on behalf of The Self-Denial Fund:
 General BOOTH

THE BENEDICTION

THE Self-Denial Fund of the Salvation Army is one of the few causes that needs no introduction to any listener, for a distinctive part of the Army's policy has always been to make itself and all its many activities known to all sorts and conditions of men. General Booth, too, has become well known to the public in the fifteen years since he succeeded his father as General of the Salvation Army.

The address to which donations to the Fund should be sent is The Salvation Army, 101, Queen Victoria Street, London, E.C.4.

9.0 TIME SIGNAL, GREENWICH; WEATHER FORECAST, GENERAL NEWS BULLETIN; Local Announcements

9.15 EMILIO COLOMBO and his ORCHESTRA

Relayed from the HOTEL VICTORIA

Turkish March *Mozart*

JOHN PATTERSON (Tenor), with Orchestra

On With the Motley ('Pagliacci') .. *Leoncavallo*

ORCHESTRA

Berceuse Tendre *Daniderff*

Valse, 'Blue Danube' *Johann Strauss*

EMILIO COLOMBO (Solo Violin)

Andante and Finale from Violin Concerto
 *Mendelssohn*

WINIFRED COOMBS (Soprano), with Orchestra

Cavatina, 'Roberto, tu che Adoro' ('Robert the
 Devil') *Meyerbeer*

ORCHESTRA

Selection from 'Martha' *Flotow*



JOSEPH'S DREAM.

EMILIO COLOMBO

Poem *Fibich*
 Beautiful Rosemary (Schön Rosmarin) *Kreisler*
 Obertass Mazurka *Wieniawski*

WINIFRED COOMBS and JOHN PATTERSON with
 Orchestra

Duet, 'Miserere' ('Il Trovatore') *Verdi*

ORCHESTRA

New Selection of Italian Popular Songs

..... *arr. Colombo*

Parisian Song, 'Fleur d'Amour' *Padilla*
 In a Monastery Garden *Ketelbey*

10.45

EPILOGUE

5XX

DAVENTRY.

1,600 M.

10.30 a.m. Time Signal, Weather Forecast

3.30-6.0 S.B. from London

8.0 S.B. from London

9.10 Shipping Forecast

9.15-10.45 S.B. from London

5IT

BIRMINGHAM.

326.1 M.

3.30

CLASSICAL FAVOURITES

THE STATION ORCHESTRA

Overture to 'Rosamunde' *Schubert*

FLORENCE HOLDING (Soprano)

Nymphs and Shepherds *Purcell*

My Heart Ever Faithful *Bach*

Whither? *Schubert*

Hark, Hark, the Lark *Schubert*

PURCELL'S song comes from a play by Shadwell, *The Libertine*, one of many for which he wrote incidental music. The words are a jolly invitation to lads and lasses to come away to sport and play, 'for this is Flora's holiday.'

MY Heart Ever Faithful is an Air from one of Bach's Cantatas—*God so Loved the World*. It is a song of gladness:—'My heart ever faithful, sing praises, be joyful, thy Saviour is near!'

THE first of the two Schubert songs is one of the cycle entitled *The Fair Maid of the Mill*, settings of poems by Wilhelm Müller. A miller's apprentice goes off to see the world. *Whither?* is the question he puts to a brooklet beside which he takes his way. 'You will find your mill to turn, some day,' is his reflection, 'and I'll find my work waiting for me too—some-where, some day.'

Concerning *Hark, Hark*, the story goes that one day Schubert met a friend in the garden of a country inn, who was reading Shakespeare. Schubert took up the book, which opened at 'Cymbeline,' at the poem 'Hark, hark, the lark at Heaven's gate sings,' which Cloten's musicians perform to Imogen, to wake her sweetly in the morning. 'Oh!' said Schubert, 'I have thought of such a lovely tune for that! What a pity I haven't some music paper here!' The friend took up the bill of fare and drew some staves on it, and Schubert at once wrote the music that so beautifully fits the poem.

ORCHESTRA

The 'Pathetic' Symphony—Third and Fourth
 Movements *Tchaikovsky*

THE THIRD MOVEMENT is a Scherzo. Throughout most of this Movement Strings and Woodwind maintain a delicate swift flight of notes. But there is an unmistakably military,

PROGRAMMES FOR SUNDAY (February 20)

even heroic, feeling in the March-tune which very soon appears and swells over the whole Orchestra.

In the **FOURTH MOVEMENT** (Slow and lamenting, then somewhat quicker) the moods pass through pathos and pity to final despair—a sadly appropriate ending to the Composer's last Symphony. Death overtook him within three months of the completion of the work.

SOLLOWAY (Violin)

Chaconne (For Violin alone) *Bach*

THIS piece is one of the Movements in Bach's Partita Suite in D Minor. The Chaconne was an old dance-form, but this example is far removed from anything dance-like, being an elaborate movement in the form of a Theme and Variations.

The Theme is a broad melody in a minor key, eight bars long and in three-beat time, most of it harmonized by chords across four strings of the Violin. The succeeding Variations, which expand the harmonies rather than the melody of the Theme, run into each other without a break. There are twenty-nine of them, Nos. 15 to 23 being in the major key.

FLORENCE HOLDING

Who is Sylvia? *Schubert*
The Vain Suit *Brahms*
Solweig's Song *Grieg*

ORCHESTRA

Minuet *Boccherini*
Chorale Variation from Cantata, No. 140
Bach, arr. Bantock

SOLLOWAY

Romanza Andaluza *Sarasate*
Fantasia on 'Carmen', *Bizet, arr. Hubay*

ORCHESTRA

Slavonic Dances, Nos. 1 and 2 from First Set *Dvorak*
Hungarian Dances, Nos. 5 and 6 *Brahms*
Dance of the Sugar Plum Fairy *Suite*
Waltz of the Flowers *Tchaikovsky*

5.15-6.0 S.B. from London

8.15 RELIGIOUS SERVICE

FROM THE STUDIO.

Introit, 'Comfort, O Lord' *Crotch*
Hymn, 'Alleluia, Song of Sweetness' (English Hymnal, No. 63)

Reading

Anthem, 'What Are These?' *Stainer*

Address by the Rev. JOHN LEWIS (of Broad Street Presbyterian Church)

Hymn, 'We Love the Place, O God' (English Hymnal, No. 598)

8.55-10.45 S.B. from London (9.10 Local News)

6BM BOURNEMOUTH. 491.8 M.

3.30-6.0 S.B. from London

8.0 FULL CHURCH SERVICE

Relayed from the Punshon-Memorial Church
Address by the Rev. S. W. ALLEN

8.55-10.45 S.B. from London (9.10 Local News)

5WA CARDIFF. 353 M.

3.30 PONTYPOOL TOWN AND DISTRICT SILVER BAND, conducted by J. B. YORKE

Overture to 'Semiramide' *Rossini*

MARGARET WILKINSON (Soprano)

E'en as a Lovely Flower *Frank Bridge*
Oh! Had I Jubal's Lyre, from 'Joshua' *Handel*

HANDEL'S Air is a song of rejoicing and of praise to God for the preservation of a loved one:

Oh, had I Jubal's lyre,
Or Miriam's tuneful voice,
To sounds like his I would aspire,
In songs like hers rejoice.
My humble strains but faintly show
How much to Heav'n and thee I owe.

BAND

A Sunday Parade *Hawkins*

Trombone Solo, 'The Winding Spirit' .. *Gough*

(Soloist: G. MERRIT)

WATCYN WATCYN (Baritone)

The Carpet } *Sanderson*

Pass, Everyman }

King Charles *Victoria White*



THE PUNSHON MEMORIAL CHURCH,

from which the first of a series of services will be broadcast by Bournemouth Station at 8.0 to-night.

BAND

Intermezzo, 'Bells Across the Meadow' .. *Ketelbey*
Cornet Solo, 'I'll Sing Thee Songs of Araby' *Clay*

(Soloist: E. LEWIS)

MARGARET WILKINSON

She Wandered Down the Mountain Side .. *Clay*
God's Garden *Lambert*
Faery Song *Boughton*

RUTLAND BOUGHTON'S Music Drama *The Immortal Hour* was produced in August, 1914, at the Summer Festival of the Glastonbury Festival School. Since then it has become one of the most popular of such works ever seen in England, having had more than one long run at London theatres.

The *Faery Song* is the haunting air sung by Midir, a Prince of the Faery folk, to Etain, a Princess from the same country, who has strayed among the humans. Midir at last lures Etain back to faeryland.

BAND

Oriental Scene, 'In a Persian Market' .. *Ketelbey*

WATCYN WATCYN

In Summertime on Bredon *Graham Peel*

The Fortune Hunter *Charles Willeby*

GRAHAM PEEL is a North Countryman (he was born near Manchester in 1877) who seems to take special pleasure in the things of nature. This song, from the *Shropshire Lad* cycle of Housman, is a universal favourite.

The singer thinks how he and his love would lie on Bredon Hill of a Sunday morning listening to the church bells pealing round the shires.

'Oh, peal upon our wedding,' he said, 'and we will hear the chime.'

But his love has died and left him, she 'went to church alone.'

The bells they sound on Bredon
And still the steeples hum.
'Come all to church, good people.'
Oh, noisy bells, be dumb;
I hear you, I will come.

BAND

Chorus, 'Hallelujah' ('The Messiah') .. *Handel*

5.15-6.0 S.B. from London

8.15 RELIGIOUS SERVICE

FROM THE STUDIO

THE CHOIR OF LLANISHEN CHURCH

Hymn, 'The King of Love My Shepherd Is' (E. H., No. 490)

A Short Reading from the Scriptures

Hymn, 'Praise, My Soul, the King of Heaven' (E. H., No. 470)

Anthem, 'God So Loved the World' *Stainer*

Religious Address by the Rev. R. L. RHYS

Hymn, 'O Strength and Stay' (Tune: Jackson) (E. H., No. 271)

8.55 THE WEEK'S GOOD CAUSE: 'The Bristol Certified Discharged Prisoners' Aid Society

9.0 S.B. from London (9.10 Local News)

10.50-11.5 'THE SILENT FELLOWSHIP'

2ZY MANCHESTER. 384.6 M

3.30 FOUR RECITALS

SONG RECITAL

JOHN VAN ZYL (Bass)

Salt-Water Ballads:

Port of Many Ships }

Trade Winds }

Mother Carey }

Hell's Pavement }

A Wanderer's Song } *Keel*

A Sailor's Prayer }

Bill the Seaman }

Sea Fever } *Ireland*

Rolling Stone } *Hamblen*

'CELLO SOLOS

CLYDE TWELVETREES

Ave Maria *Max Bruch*

Intermezzo *Granados*

Allegro Spiritoso *Senaille, arr. Salmon*

Notturmo *Julius Klengel*

Lament }

A Child's Dream } *Clyde Twelvetrees*

SONGS OF EVENTIDE

THE VICTORIAN TRIO

Night *Hamish MacCunn*

June Roses *Schumann*

O Peaceful Night *Edward German*

(Unaccompanied)

Sweet and Low *Barnby*

All Thro' the Night *Old Welsh Air*

O Hush Thee, My Babe *Arthur Sullivan*

Absent *Metcalf*

SCARLATTI

CLAUD BIGGS (Pianoforte)

Prestissimo in B Flat Major

Pastorale in F Major

Presto in F Major

Pastorale and Capriccio

Allegro in G Major

Presto in A Major

5.15-6.0 S.B. from London

8.0-10.45 S.B. from London (9.10 Local News)

PROGRAMMES FOR SUNDAY (February 20)

6KH HULL. 294 M.

3.30-6.0 } S.B. from London (9.10 Local News)
8.0-10.45 }

2LS LEEDS-BRADFORD. 277.8 M. & 252.1 M.

3.30-6.0 S.B. from London

8.15 RELIGIOUS SERVICE

Relayed from Horton Lane Congregational Church, Bradford
Address by the Rev. Prof. E. J. PRICE
HORTON LANE CONGREGATIONAL CHURCH CHOIR

8.55-10.45 S.B. from London (9.10 Local News)

6LV LIVERPOOL. 297 M.

3.30-6.0 S.B. from London

8.15 RELIGIOUS SERVICE

Relayed from St. James's Church, Toxteth Park
Address by the Rev. T. R. DANN, Secretary of the Liverpool Free Church Centre

8.55-10.45 S.B. from London (9.10 Local News)

5NG NOTTINGHAM. 275.2 M.

3.30-6.0 S.B. from London

8.0 BELLS of St. Mary's Church, Nottingham

8.10 RELIGIOUS SERVICE

Relayed from St. Mary's Church
Hymn (No. 165, A. and M.)
Psalm 99
Magnificat
Anthem, 'Evening and Morning'..... Oakeley
Address: The Rt. Rev. the BISHOP of SOUTHWELL
Hymn (A. and M., No. 27)

8.55-10.45 S.B. from London (9.10 Local News)

5PY PLYMOUTH. 400 M.

3.30-6.0 S.B. from London

8.0 RELIGIOUS SERVICE

Relayed from George Street Baptist Church
Organ Prelude by Mr. T. MARTIN, F.R.C.O.
Hymn, 'Praise My Soul, the King of Heaven'
(Baptist Church Hymnal, No. 599)

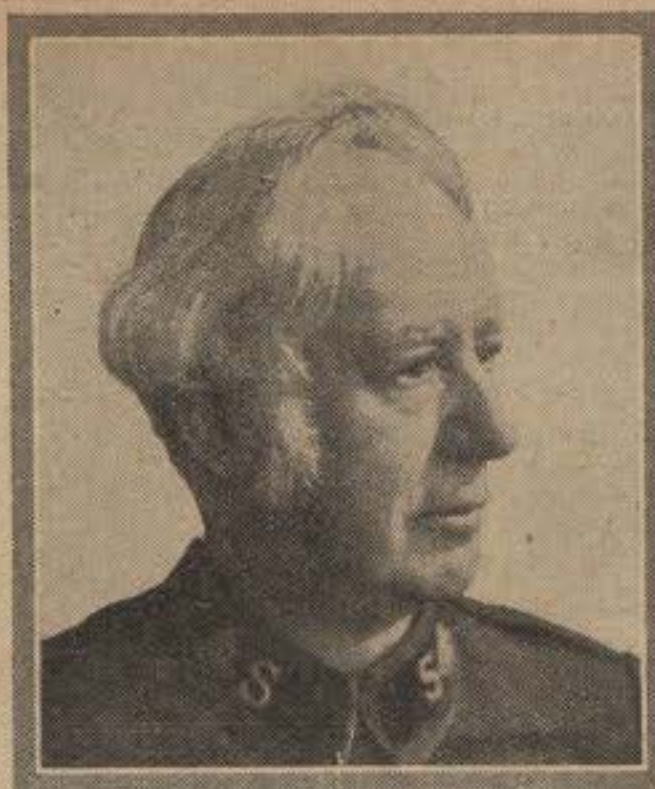

GENERAL BOOTH,

the head of the Salvation Army, speaks in the service that the Army gives from the London Studio to-day, and makes the appeal for the Self-Denial Fund.

Invocation and Lord's Prayer
Magnificat

Scripture Reading, Isaiah xxxv.
Anthem, 'How Lovely Are the Messengers'
(Mendelssohn) (George Street Church Choir)

Intercessions
Hymn, 'Jesus Shall Reign Where'er the Sun'
(B.C.H., No. 549)

Address by the Rev. F. W. NORWOOD, D.D.,
Minister of the City Temple, London

Hymn, 'It Came Upon the Midnight Clear'
(B.C.H., No. 83)

Benediction and Vesper

8.55 THE WEEK'S GOOD CAUSE: An Appeal by Mr. H. J. DRAPER on behalf of the University College of the South-West

9.0-10.45 S.B. from London (9.10 Local News)

6FL SHEFFIELD. 272.7 M.

3.30-6.0 } S.B. from London (9.10 Local News)
8.0-10.45 }

6ST STOKE. 294 M.

3.30-6.0 S.B. from London

8.15 RELIGIOUS SERVICE

From the Studio
Conducted by the Rev. J. C. KEY, Rector of Shelton Church, Shelton, Stoke-on-Trent

8.55-10.45 S.B. from London (9.10 Local News)

5SX SWANSEA. 294 M.

3.30 S.B. from Cardiff

5.15-6.0 S.B. from London

8.0 S.B. from London (9.10 Local News)

10.50-11.5 S.B. from Cardiff

Northern Programmes.

5NO NEWCASTLE. 312.5 M.

3.30-6.0 and 8.0-10.35:—S.B. from London.

5SC GLASGOW. 405.4 M.

3.30:—Orchestral Concert. The Station Orchestra, conducted by Sir Hamilton Harty. Polonaise, Arietta and Passacaglia (Handel, transcribed by Harty); Siegfried Idyll (Wagner); George Parker (Baritone) and Orchestra: Slumber Now ye Weary Eyelids (Bach); Now Your Days of Philandering Are Over (Figaro) (Mozart); Hymn, Op. 33, No. 2 (Strauss). Orchestra: Poem, 'With the Wild Geese' (Hamilton Harty). George Parker: Evening Hymn (Purcell); Piping Down the Valleys Wild (Gwyther); The Noble Nature (D. Cleithorn Thomson); Roundabouts and Swings (Geoffrey Shaw). Orchestra: Three Little Pieces (Bizet); Gipsy Dance ('Fair Maid of Perth'); The Top ('Childish Games'); Adagio (The Maid of Arles); Polovtsian Dances ('Princes Igor') (Borodin). 5.15-6.0:—S.B. from London. 8.20:—The Week's Good Cause: Appeal on behalf of Relief Institutions by the Rt. Hon. Lord Provost David Mason. 8.30:—Religious Service from the Studio. Address by Rev. Archibald Craig, United Free Church, Hillhead. 9.0:—News. 9.15-10.45:—S.B. from London.

2BD ABERDEEN. 500 M.

3.30:—S.B. from Glasgow. 5.15-6.0:—S.B. from London. 8.30:—S.B. from Glasgow. 9.0:—News. 9.15-10.45:—S.B. from London.

2BE BELFAST. 306.1 M.

3.30:—S.B. from Glasgow. 5.15-6.0:—S.B. from London. 8.30:—Religious Service from the Studio. The Station Choir: Hymn, 'Praise to the Holiest in the Height.' Scripture Reading. Anthem, 'O Praise God in His Holiness' (John Weldon). Address by the Rt. Rev. B. K. Hanna, Moderator of the Presbyterian Church of Ireland. Hymn, 'The Day Thou Gavest, Lord, is Ended.' Closing Prayer and Benediction. Sevenfold Amen (Stainer). 9.0:—News. 9.15-10.45:—S.B. from London.



MANCHESTER HAS A STRONG TEAM THIS AFTERNOON.

Four special recitals occupy the Manchester programme from 3.30 this afternoon. Here you see the artists who will take part in three of them. From left to right: Mr. John Van Zyl, the bass singer; Miss Jessie Mitchell, Miss Frances Frost, and Miss Molly Street, the members of the Victorian Trio; and Mr. Claud Biggs, who interprets Scarlatti on the pianoforte.

PROGRAMMES FOR MONDAY (February 21)

2LO LONDON. 361.4 M.

(1.0 Time Signal, Big Ben)

1.0-2.0 ORGAN RECITAL

HAROLD E. DARKE, Mus.Doc., F.R.C.O.
Relayed from St. Michael's Church, Cornhill

Voluntary in A J. Nares
Andante tranquillo (from Parry's 'Little Organ Book') Harold Darke
Prelude, 'Vexilla Regis' Bairstow
Tocata, 'Pange Lingua' J.
Prelude and Fugue in A Major Bach
Andantino Franck
Minuet and Variations Handel
Marche Pontificale Widor

2.55 Reading: 'Sailing Round the World,' by Captain Slocum

3.0 Mrs. CHARLOTTE MANSFIELD: 'Madagascar'

3.15 SPEECH BY
H.R.H. PRINCE GEORGE
at the Annual Meeting of the
SEAMEN'S HOSPITAL SOCIETY
Relayed from
The Hotel Cecil

3.20 Mrs. CHARLOTTE MANSFIELD: 'Madagascar' (Continued)

3.30 HALLOWING OF LEICESTER CATHEDRAL
Relayed from LEICESTER

The Thanksgivings

The Hallowing of the diocese and of the Cathedral Church, the setting therein of the Bishop's stool and the dedication of the restorations and additions to the fabric of the Church.
Psalm 150

Hymn, 'City of God' (E.H., 375)

Sermon by the Right Rev. the Lord BISHOP OF WINCHESTER, D.D.

Hymn at the time of offering, 'For All the Saints' (E.H., 641)

Blessing by the Lord BISHOP OF LEICESTER, D.D.
The Primal Blessing by His Grace the ARCHBISHOP OF CANTERBURY

4.15 Prof. G. ELLIOT SMITH, 'The Movements of Living Creatures'

THIS is the sixth of Professor Elliot Smith's talks, and he has now advanced to the comparison between such slow and clumsy creatures as the lobster and the crab, with their series of complicated limbs and appendages, and the graceful, swift-moving fish. This difference, however, depends less upon the shape of the creature than upon the efficiency of its nervous system, and in particular of the labyrinth, or statocyst, of which he spoke last week.

4.30 THE ROYAL AUTOMOBILE CLUB DANCE BAND from the R.A.C.

5.0 Household Talk: Miss N. B. WILLIAMS, 'Economies in Food'

5.15 THE CHILDREN'S HOUR: Piano Solos by CECIL DIXON; Songs by REX PALMER; 'The Colonel's Strange Recruit' (David Ker); 'The Little Things That Count in Rugby Football,' by Major LEONARD R. TOSSWILL

6.0 ALEX FRYER'S ORCHESTRA, from the Rialto Theatre

6.30 TIME SIGNAL, GREENWICH; WEATHER FORECAST, FIRST GENERAL NEWS BULLETIN

6.45 ALEX FRYER'S ORCHESTRA (Continued)

7.0 Mr. JAMES AGATE gives a quarter of an hour of his lively Dramatic Criticism

7.15 SCHUMANN'S 'POET'S LOVE'
Sung by DALE SMITH

SCHUMANN'S happy marriage, at the age of thirty, seems to have been a wonderful incentive to composition.

In one form, especially in song, he poured out his emotions. Over a hundred songs were composed in that first year of married life. Among them was this cycle of sixteen songs, entitled *The Poet's Love* (*Dichterliebe*, in German).

The words are by Heine, the poet who, forbidden to live in his native land, spent some

time in London, and ended his days in France, in bodily suffering.

The story first traces the growth of love in the heart of the poet. Suddenly comes his sorrow. His loved one is lost to him.

He seeks to escape, in solitude, his sad recollections, but the image of the lost one is ever poignantly before him.

Finally, resigned to the fading of his dreams, he would put away his memories and bury in a mighty coffin all his sorrow and love, intermingled.

To-night we are to have half of the cycle—the first nine songs.

7.25 Mr. W. F. BLETCHER: Spanish Talk. S.B. from Manchester

7.45 WINNERS

Reminiscences of well-known numbers from Musical Plays, with linked dialogue by MABEL CONSTANDUROS



Woodcut by Gram Golden

By courtesy of the Edison Co. Ltd.

ROBERT SCHUMANN (1810-1856),

the German composer whose haunting melodies captured the world nearly a century ago. Some of the most famous of them are being sung by Mr. Dale Smith in the evening Classical Recitals this week. [London 7.15.]

THE WIRELESS ORCHESTRA

Conducted by
JOAN ANSELL

9.0 TIME SIGNAL, GREENWICH; WEATHER FORECAST, SECOND GENERAL NEWS BULLETIN; Local Announcements

9.15 THE WIRELESS ORCHESTRA
Selection, 'The Rose' Myddleton

9.30 H.R.H. THE PRINCE OF WALES

Speaking at
THE BRITISH INDUSTRIES FAIR BANQUET
at the
MANSION HOUSE
Relayed from the Mansion House

9.45 VARIETY

LESLIE WESTERN (Entertainer)

MARIE DAINTON (Selections from her Repertoire)

MARIE DAINTON believes that broadcasting affords the artist of originality greater scope than any other medium, and even those of her admirers who think they know her work well will find to-night that she can show them something new.

10.15-11.15 A PROGRAMME OF ERIC FOGG'S MUSIC

Conducted by THE COMPOSER

ISABEL F'ANSON (Soprano)

DALE SMITH (Baritone)

KATHLEEN MOORHOUSE (Solo Violoncello)

At the Piano—THE COMPOSER

THE WIRELESS ORCHESTRA



Mr. ERIC FOGG.

ANYONE who attended the famous Hallé Concerts at Manchester for thirty-five consecutive seasons must have constantly heard one man at the organ throughout the whole period. This was C. H. Fogg, who was Organist to the Hallé Society during all those years, and was, in fact, one of the best-known

practising musicians in the North.

His son is Eric Fogg, born in February, 1903. By 1920, Eric Fogg could already claim a very considerable output of music, and in that year he conducted a Ballet of his at a Queen's Hall Prom.

In the last seven years he has simplified his style, and has already published a great deal of music which, in the opinions of many, not merely shows promise, but gives us actual achievement.

To-night we are to hear representative works by this Composer, in the performance of which we have the advantage of his co-operation.

ORCHESTRA

Orchestral Poem, 'Sea Sheen'

ISABEL F'ANSON (with Orchestra)

Three Chinese Songs:

Tao Kivao; Tsuya Dreams; Broken Trust

DALE SMITH (with Orchestra)

Peace

Hunting Song of the Seconee Pack

Introduction and Allegro for Flute, Oboe, Clarinet, Horn and Piano. (First Performance)

FRANK ALMIGILL (Flute); JOHN FIELD (Oboe);

FREDERICK THURSTON (Clarinet); FRANK

PROBYN (Horn) and

The Composer

ISABEL F'ANSON

Two Blake Songs (To Morning; Laughing Song)

Evening

When Passion's Trance is Overpast

KATHLEEN MOORHOUSE and THE COMPOSER

Poem for Violoncello and Piano

DALE SMITH

The Dove

The Devon Maid

The Dismantled Ship

Sing a Song of Cricketers

ORCHESTRA

Prelude, 'Past the Sweet Lilac Clover-field'

5XX DAVENTRY. 1,600 M.

10.30 a.m. Time Signal, Weather Forecast

11.0 TIME SIGNAL, BIG BEN. THE DAVENTRY QUARTET and HEBE SIMPSON (Soprano, in Songs with Violin played by herself); STANLEY POPE (Bass-Baritone); ORREA PERNEL (Violin); EDITH HEYMAN (Pianoforte)

1.0-2.0 S.B. from London

2.55 S.B. from London

7.25 S.B. from Manchester

7.45 S.B. from London

9.10 Shipping Forecast

9.15 S.B. from London

11.0-12.0 DANCE MUSIC

JACK HOWARD and his BAND from the Royal Opera House, Covent Garden

PROGRAMMES FOR MONDAY (February 21)

5IT BIRMINGHAM. 326.1 M.

- 3.45 THE STATION PIANOFORTE QUINTET
- 4.45 AFTERNOON TOPICS: Mr. SIDNEY ROGERS, 'Topical Horticultural Hints—Michaelmas Daisies.' GRACE MILLINGTON (Soprano)
- 5.15 THE CHILDREN'S HOUR: Fairy Story by GLADYS COLBOURNE. Songs by HAROLD CASEY (Baritone). Children's Play: 'Erbut Takes His Family to the Tower,' written by C. E. Hodges
- 6.0 HAROLD TURLEY'S ORCHESTRA, relayed from Prince's Café
- 6.30 S.B. from London
- 7.25 Mr. W. F. BLETCHER, Spanish Talk. S.B. from Manchester



Mr. Herbert Parker (left), bass, will sing two groups of songs, and Mr. Arthur Kennedy will give some viola solos, in the Orchestral Programme from Birmingham from 9.45 to 11.0 to-night.

7.45 S.B. from London (9.10 Local News)

9.45-11.0 ORCHESTRAL PROGRAMME

- THE STATION ORCHESTRA
Overture to 'Shamus O'Brien' Stanford
- HERBERT PARKER (Bass)
Where the Tisza's Torrents } Korbay
Far and High the Cranes Give Cry }
Had a Horse }
- ORCHESTRA
Selection from 'Mefistofele' Boito
- FRANCES MORRIS (Soprano)
Shepherd's Song Elgar
I will Walk with My Love Herbert Hughes
Charming Chloe German
- ARTHUR KENNEDY (Viola)
Sonata for Viola Grazioli
Allegro Appassionato Frank Bridge
- ORCHESTRA
Introduction to Act III, 'Lohengrin' .. Wagner
- L**OHENGRIN is a Knight of the Holy Grail who comes to champion the wrongfully accused maiden, Elsa, and marries her.
The Prelude to Act III of the Opera gives the atmosphere of festivity and thanksgiving which follows the marriage.
- HERBERT PARKER
Hope, the Hornblower Ireland
The Blacksmith Koenemann
Lorraine, Lorraine, Lorraine Capel
- ORCHESTRA
Saltarello (Fourth Symphony, the 'Italian') Mendelssohn
- FRANCES MORRIS
Prelude Cyril Scott
Love's Philosophy Roger Quilter
I Have Twelve Oxen John Ireland
- ORCHESTRA
Suite, 'The Two Pigeons' (Part I) Messenger
Entry of the Gipsies; Scene and Dance of the Two Pigeons; Theme and Variations

6BM BOURNEMOUTH. 491.8 M.

- 3.0 London Programme relayed from Daventry
- 5.15 THE CHILDREN'S HOUR
- 6.0 ORCHESTRAL MUSIC relayed from the Grand Super Cinema, Westbourne. Directed by ISADORE GODOWSKY
- 6.30 S.B. from London
- 7.25 Mr. W. F. BLETCHER, Spanish Talk. S.B. from Manchester
- 7.45-11.15 S.B. from London (9.10 Local News)

5WA CARDIFF. 353 M.

- 12.30-1.30 Lunch-Time Music from the Carlton Restaurant
- 3.15 BROADCAST TO SCHOOLS: Mrs. E. FIELDEN HODGSON, 'Primitive Life and Folk Tales—In the Balkans'
- 3.40 AN ORCHESTRAL CONCERT
THE STATION ORCHESTRA
Suite, 'In a Russian Village' Marsden
Waltz, 'España' Waldteufel
Overture to 'Zampa' Herold
Suite, 'Sylvan Scenes' Fletcher
- 4.15 London Programme relayed from Daventry
- 4.30 ORCHESTRA
Ballet Suite, 'Louis XIV' Poullet
- 4.45 Miss FRANCES M. ENGLAND, 'Women Pioneers in Education'
- 5.0 ORCHESTRA
Hillside Melody Phillips
Three Dances ('Nell Gwyn') German
- 5.15 THE CHILDREN'S HOUR
- 6.0 Miss EDITH CEDERVALL, 'Prose Writers of the 19th Century—Macaulay'
- 6.15 ORCHESTRA
Entr'acte, 'Village Green' Clarke
Four Dances ('The Rebel Maid') Phillips
- 6.30 S.B. from London
- 7.25 Mr. W. F. BLETCHER, Spanish Talk. S.B. from Manchester

7.45 ORCHESTRAL MASTERPIECES

- ENGLAND
- THE STATION ORCHESTRA
Overture, 'The Butterfly's Ball' Cowen
Shepherd Fennel's Dance Balfour Gardiner
- Vocal Interlude 1
- HERBERT HEYNER (Baritone)
Requiem Sidney Homer
Eleanore Coleridge-Taylor
Four Jolly Sailors German
- FRANCE
- ORCHESTRA
L'Apprenti Sorcier Dukas
L'Après-Midi d'un Faune Debussy
- Vocal Interlude 2
- HERBERT HEYNER
The Jealous Lover } (From Five Jacobean
I Dare Not Ask a Kiss } Lyrics) Quilter
The Constant Lover }
- GERMANY and RUSSIA
- ORCHESTRA
Till Eulenspiegel's (Merry Pranks) Strauss
Siegfried's Journey to the Rhine ('The Dusk of the Gods') Wagner
Finale of the Opera Ballet, 'Mlada' Rimsky-Korsakov, arr. Borodin
- 9.0 S.B. from London (9.10 Local News)
- 9.45 THE SPIRIT OF CARNIVAL
- THE STATION ORCHESTRA
Symphonic Poem, 'Festive Sounds' Liszt

- HERBERT HEYNER (Baritone)
The Calf of Gold (Faust) Gounod
- ORCHESTRA
Overture, 'Carnival' Dvorak
- HERBERT HEYNER
Song of Queen Mab ('Romeo and Juliet') Gounod
- ORCHESTRA
Dance of the Apprentices ('The Mastersingers') Wagner
Carnival (Rustic Suite) Glazounov

10.30-11.5 VARIETY

- DANCE MUSIC by ARCHIBALD L. GRIFFITHS' DANCE BAND
GEORGE STOCKWIN and FRED BECK
In Character Studies, Songs and Sketches
DANCE MUSIC (Continued)



AT MANCHESTER TO-NIGHT.

On the left is Mr. George Hill, baritone, who sings in the programme of Sea Shanties and Army Songs at 9.45 to-night, and on the right Mr. Tom Rogers, 'the musical postman,' who figures in the Variety Programme at 7.45.

2ZY MANCHESTER. 384.6 M.

- 3.25 BROADCAST TO SCHOOLS: Mr. EDWARD CRESSY, 'Great Canals of the World—(VI) The Manchester Ship Canal' (11)
- 3.45 WILLIAM THRELFALL (Baritone)
Because I Love You Irving Berlin
Bye-Bye, Blackbird Ray Henderson
Where'd You Get Those Eyes? Walter Donaldson
How Many Times? Irving Berlin
When the Red, Red Robin Harry Woods
- 4.0 ORCHESTRAL MUSIC from the Piccadilly Picture Theatre
- 5.0 AFTERNOON TOPICS: Miss MARGARET RADCLIFF, 'A Question of Taste' (In the form of a Dialogue)
- 5.15 THE CHILDREN'S HOUR: Children's Songs from Many Lands—(2) Norway. (Sung by HARRY HOPEWELL.) Asgard and Its King, a Norse Legend
- 6.0 THE MAJESTIC 'CELEBRITY' ORCHESTRA, from the Hotel Majestic, St. Anne's-on-the-Sea. Musical Director, GERALD W. BRIGHT
- 6.30 S.B. from London
- 6.45 THE MAJESTIC 'CELEBRITY' ORCHESTRA (Continued)
- 7.0 S.B. from London
- 7.25 Mr. W. F. BLETCHER, Spanish Talk.
- 7.45 A VARIETY PROGRAMME
Introduced and announced by JOHN HENRY TOM ROGERS (The Musical Postman)
Waltz, 'Blue Bird Harmonica' Original
In a Monastery Garden Ketelbey
Mouth Organ Solo, Selection from 'Martha' Flotow
Plantation Melody Traditional

PROGRAMMES FOR MONDAY (February 21)

JEANE PAULE and LEONIE LASCELLES
Introduce a Piano—And Themselves, in Harmony
Syncopation and Comedy Duets
DORIS PALMER (Comedienne)
TOMMY HANDLEY in some nonsense

9.0 *S.B. from London* (9.10 Local News)

9.45 **SEA SHANTIES AND ARMY SONGS**
GEORGE HILL (Baritone) and MALE VOICE CHORUS
Shanties:
Clear the Track *arr. R. R. Terry*
Roll the Cotton Down *arr. Taylor Harris*
Billy Boy *arr. R. R. Terry*
Jack the Jolly Tar O *arr. Cecil Sharp*
Army Songs:
There's a Tavern in the Town *Anon.*
Come, Landlord, Fill the Flowing Bowl
..... *arr. T. K. L.*
Shanties:
Blow the Man Down } *arr. R. R. Terry*
Hanging Johnny }
The Hog's-Eye Man }
Army Songs:
The Sergeant's Song *Foss*
Marching Thro' Georgia *H. C. Work*

10.15-11.15 *S.B. from London*

6KH HULL 294 M.

11.30-12.30 Gramophone Records
3.30 Light Music
4.0 AFTERNOON TOPICS: Miss HANSEN
DRASDO, 'Four Norwegian Authors—(3)
Hamsun'
4.15 FIELD'S QUARTET, relayed from the New
Restaurant, King Edward Street
5.15 THE CHILDREN'S HOUR
6.0 London Programme relayed from Daventry
6.30 *S.B. from London*
7.25 *S.B. from Manchester*
7.45-11.15 *S.B. from London* (9.10 Local News)

2LS LEEDS-BRADFORD, 277.8 M. & 252.1 M.

4.0 THE SCALA SYMPHONY ORCHESTRA, relayed
from the Scala Theatre, Leeds
5.0 AFTERNOON TOPICS: M. K. DODGSON, 'The
Countryside Again'
5.15 THE CHILDREN'S HOUR
6.0 Light Music
6.30 *S.B. from London*
7.25 *S.B. from Manchester*
7.45-11.15 *S.B. from London* (9.10 Local News)

6LV LIVERPOOL 297 M.

11.30-12.30 Midday Gramophone Lecture Recital
by MOSES BARITZ
4.0 PATRIZOV and his ORCHESTRA from the
Futurist Cinema
5.0 AFTERNOON TOPICS: Mr. CHARLES W. BUDDEN,
'The Village Church of Old England—(8) The
Story of the Altar'
5.15 THE CHILDREN'S HOUR
6.0 MONTAGUE'S SYMPHONICS, relayed from the
Edinburgh Café Ballroom
6.30 *S.B. from London*
7.25 Señor A. M. DUARTE, Spanish Talk
7.45-11.15 *S.B. from London* (9.10 Local News)

5NG NOTTINGHAM. 275.2 M.

3.5 BROADCAST TO SCHOOLS: Mr. A. H. WHITTLE,
'Nature Talk'
3.30 London Programme relayed from Daventry
4.15 THE MIKADO CAFÉ ORCHESTRA, conducted
by FREDERICK BOTTOMLEY
4.45 Miss DUTTON, 'Pilgrim Mothers'
5.15 THE CHILDREN'S HOUR
6.15 MABEL HODGKINSON (Pianoforte)
6.30 *S.B. from London*
7.25 *S.B. from Manchester*
7.45-11.15 *S.B. from London* (9.10 Local News)

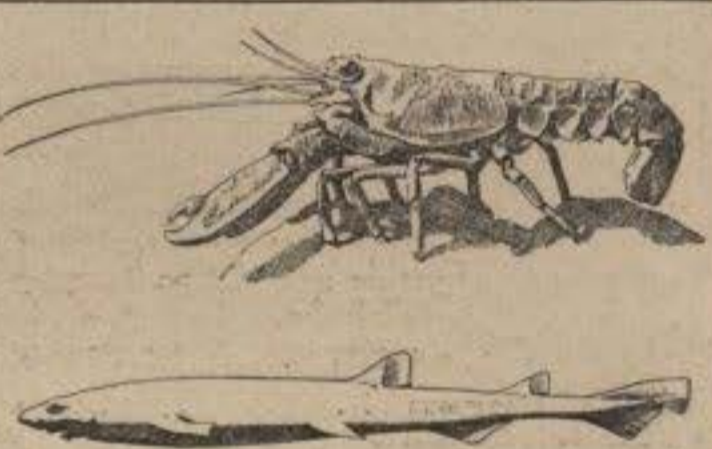

THE HARE AND TORTOISE OF THE SEA.
The lobster has a marvellous array of legs, and
as many gadgets as a schoolboy's knife, but he
spends most of his time trying to make them
work. The contrast between his slow movements
and the swift grace of the dogfish will be explained
by Professor Elliot Smith in his talk from London
this afternoon.

5PY PLYMOUTH. 400 M.

11.0-12.0 GEORGE EAST and his QUARTET,
relayed from Popham's Restaurant
3.30 ORCHESTRA, relayed from Popham's Res-
taurant
4.0 Afternoon Topics
4.15 TEA-TIME MUSIC: THE ROYAL HOTEL TRIO,
directed by ALBERT FULLBROOK
5.15 THE CHILDREN'S HOUR
6.0 EDNA STITSON (Pianoforte Recital)
6.30 *S.B. from London*
7.25 *S.B. from Manchester*
7.45-11.15 *S.B. from London* (9.10 Local News)

6FL SHEFFIELD. 272.7 M.

11.30-12.30 Gramophone Records
4.0 Afternoon Topics
4.15 ORCHESTRA, relayed from the Grand Hotel
5.15 THE CHILDREN'S HOUR: Half an Hour with
the Fairies. Fairy Songs, Fairy Tales and Fairy
Music
6.0 STUDIO RECITAL
JOHN ATKINSON (Violin) and GEOFFREY TANCRED
(Piano)
First Two Movements from Sonata in A
Cesar Franck

JOHN ATKINSON
Hymn to the Sun *Rimsky-Korsakov*
Viennese Melody *Kreisler*
Slavonic Dance *Deorak, arr. Kreisler*
GEOFFREY TANCRED
Valse in E Minor *Chopin*
Nocturne *Chopin, arr. Liszt*
Marche Militaire *Schubert, arr. Tausig*

6.30 *S.B. from London*
7.25 *S.B. from Manchester*
7.45-11.15 *S.B. from London* (9.10 Local News)

6ST STOKE. 294 M.

3.0 London Programme relayed from Daventry
5.15 THE CHILDREN'S HOUR
6.0 Light Music
6.30 *S.B. from London*
7.25 *S.B. from Manchester*
7.45-11.15 *S.B. from London* (9.10 Local News)

5SX SWANSEA. 294 M.

3.0 London Programme relayed from Daventry
5.0 Mr. J. C. GRIFFITH-JONES, 'Just Jones'
5.15 THE CHILDREN'S HOUR
6.0 VERA WARMINGTON (Soprano)
6.30 *S.B. from London*
7.25 *S.B. from Manchester*
7.45 *S.B. from Cardiff*
9.0 *S.B. from London* (9.10 Local News)
9.45-11.5 *S.B. from Cardiff*

Northern Programmes.

5NO NEWCASTLE. 312.5 M.

3.0—London Programme relayed from Daventry. 3.30—
Mr. Edgar L. Bainton, 'Descriptive Music.' 4.0—Music from
Coxon's New Gallery Restaurant. 5.0—London Programme re-
layed from Daventry. 5.15—Children's Hour. 6.0—The
Station Octet. 6.25—Radio Society Bulletin. 6.30—S.B.
from London. 7.25—S.B. from Manchester. 7.45-11.15—
S.B. from London.

5SC GLASGOW. 405.4 M.

3.0—Dance Music relayed from the Piccadilly Dance Club.
4.0—Works by Puccini. The Wireless Quartet. 5.0—After-
noon Topics: Augustus Beddell, 'Scots Reading—(2) Nancy
Waugh's First and Last Play.' 5.15—Children's Hour.
6.0—The Rev. Fred E. Watson, 'What is Toc H and What
is it Doing in Glasgow?' 6.10—Song Recital. Mary Jarred
(Contralto). 6.30—S.B. from London. 7.25—S.B. from Man-
chester. 7.45-11.15—S.B. from London.

2BD ABERDEEN. 500 M.

11.0-12.0—Gramophone Records. 3.45—Dance Music by
John B. Swinfen and his New Toronto Band relayed from the
New Palais de Danse. 4.15—Afternoon Topics: Miss Margaret
B. Stout, 'A Woman in Hankow.' 4.30—Dance Music relayed
from the New Palais de Danse. 5.15—Children's Hour. 6.0—
Music by the Station Octet. 6.30—S.B. from London. 7.25—
S.B. from Manchester. 7.45—S.B. from London. 9.45-11.0
app.—Old Favourites. The Station Octet. A. E. Cruickshank
(Baritone). Aileen Milne (Mezzo-Soprano).

2BE BELFAST. 306.1 M.

3.0—Broadcast to Schools: Prof. James Small, D.Sc. (Pro-
fessor of Botany, Queen's University), 'What Botany Really
Means.' 4.0—Mendelssohn. The Station Orchestra. 4.30—
Vocal Interlude: Weir McCormick (Baritone). 4.42—Dance
Music. The Station Dance Band. 5.0—Afternoon Topics:
Mrs. Liebert, 'Arts and Crafts.' 5.15—Children's Hour. 6.0—
London Programme relayed from Daventry. 6.30—S.B. from
London. 7.25—S.B. from Manchester. 7.45—S.B. from
London. 9.45—Derry Soloists. The Station Orchestra.
James P. McCafferty (Baritone). Lawrence McCann (Violin).
10.45-11.0—Dance Music. The Plaza Band, directed by R. M.
Cole, relayed from the Plaza.

PROGRAMMES FOR TUESDAY (February 22)

2LO LONDON. 361.4 M.

(1.0 Time Signal, Big Ben)

- 1.0-2.0 THE ST. JAMES STRING SEXTET and EVERARD DE PEYER (Baritone)
- 2.55 Reading: 'The Bible in Spain,' by George Borrow
- 3.0 BROADCAST TO SCHOOLS: Sir H. WALFORD DAVIES continues his informal series of talks on Elementary Music
- 3.45 WILLIAM HODGSON'S MARBLE ARCH PAVILION ORCHESTRA, from the Marble Arch Pavilion
- 4.0 TIME SIGNAL, GREENWICH. WILLIAM HODGSON'S MARBLE ARCH PAVILION ORCHESTRA (Continued)
- 5.0 Miss ANN SPICE gives listeners a good quarter of an hour with another of her talks on books and reading: 'Books to Read'
- 5.15 THE CHILDREN'S HOUR: Folk Song Duets by MURIEL GEORGE and ERNEST BUTCHER, 'The Reluctant Dragon' (Kenneth Graham)
- 6.0 THE LONDON RADIO DANCE BAND, directed by SIDNEY FIRMAN
- 6.30 WEATHER FORECAST, FIRST GENERAL NEWS BULLETIN
- 6.45 THE LONDON RADIO DANCE BAND (Continued)
- 7.0 Mr. LOUIS GOLDING: 'Castles and Caverns in Spain'

A TRAVELLER with an unflinching eye for the picturesque and a gift of describing it that is amply demonstrated in such books as 'Sunward' and 'Sicilian Noon,' Mr. Golding will have excellent scope for this descriptive power in the subject that he is to talk about to-day.

7.15 SCHUMANN'S 'POET'S LOVE'
Sung by DALE SMITH

TONIGHT we hear the second half of this song-cycle, commencing at the tenth song (*Hör ich das Liedchen—I hear the Song*). In this song the poet seeks the solitude of the mountains, to escape from his sad recollections.

Heine's ironical humour comes out in the eleventh song, *Ein Jüngling liebt ein Mädchen (A Youth once loved a Maiden)*, in which is a cynical reflection on the course of love, as it sometimes runs.

The titles of the next three songs are *Am leuchtenden Sommermorgen (On a Bright Summer Morning)*, *Ich hab' im Traum geweinet (I Wept and I Dreamt)* and *All-nächtlich im Traume (Each Night in Dreams)*. In these the poet returns to his mood of sorrowful recollection. Waking or dreaming, the image of her who is lost to him is ever poignantly before him.

In the last song but one (*Aus alten Märchen—From Old Fairy Tales*) the poet longs for the visionary land of childhood's dreams, where all is peace and contentment. But with the break of morning these sweet visions fade.

In the last song of all (*Die alten bösen Lieder—The Old, Bad Songs*) he calls for a mighty coffin, in which shall be buried all his sorrow and love intermingled.

The Pianist, in a last tender page, adds his note of regret and resignation, and so ends the story of the Poet's Love.

7.25 Prof. P. J. NOEL BAKER, 'Foreign Affairs and How They Affect Us—VI. The Outlook for the Future.' S.B. from Birmingham

IN this important series of talks the Professor of International Relations in the University of London has described, from an exceptional expert knowledge, the workings of the diplomatic machine by which the relations between countries are manipulated, and especially the comparatively new instrument, the League of Nations. He now concludes his series by dis-

cussing the outlook for the future, and listeners who have heard his previous talks will await with interest his summing-up, especially now that on so many sides are heard the Jeremiahs predicting the date of the next world war.

7.45 A PROGRAMME OF HOWARD CARR'S MUSIC

Conducted by THE COMPOSER

HOWARD CARR, a Manchester man born in 1880, has spent nearly thirty years in conducting orchestras in theatres and concert-rooms, and in composing light Operatic music and suites.

THE WIRELESS SYMPHONY ORCHESTRA

Nautical Suite, 'On the Briny'
A Last Step with Polly and Sal; The Shanty-man's Song; The Sentimental Bo'sun; Jolly Sea-Dogs
Intermezzo, 'The Crimson Fan'



By Courtesy of Jonathan Cape

CASTLES IN SPAIN.

This evening, at seven o'clock, Mr. Louis Golding is to talk from London on 'Castles and Caverns in Spain.' This drawing of the Alcazar at Toledo forms one of the illustrations to 'The Spanish Journey,' by J. H. Meier-Graefe.

Yorkshire Patrol, 'Bah Goom' (Motto—If tha does ought for nought, do it for tha' sen)

Graceful Dance, 'The Clifton Frock' (1st Performance)

Shanties and Sea Songs (collected and arranged for Male Voices and Orchestra by Howard Carr). Introduced by BOYD CABLE

Sung by FREDERICK RANALOW, with FRANK TITERTON, HOWARD FRY, ARNOLD BEAUVAIS and THE WIRELESS CHORUS

Prelude, 'The Shrine in the Wood'
Symphonic March, 'The Adventurers'

THE Composer's note on *The Shrine in the Wood* when it was first performed (at a Promenade Concert two years ago) was:—

'An impression of the reverent beauty of a great shrine built with passionate faith, and now in ruins, in the heart of a Yorkshire dale.' (Was it Fountains Abbey? The Composer was for a time conductor of the Harrogate Orchestra.)

8.45 FLORENCE OLDHAM and ALMA VANE
The Whispering Sopranos

9.0 WEATHER FORECAST, SECOND GENERAL NEWS BULLETIN; Local Announcements

9.15 Sir H. WALFORD DAVIES, 'Beethoven' (VI)

LISTENERS should endeavour not to miss this talk on Beethoven. Sir Walford Davies is, as everyone knows, a master of the microphone as well as a famous musician, and the series of addresses which he is now giving is of special interest in view of the approaching centenary of the great composer.

9.35 POPULAR CLASSICS

THE WIRELESS SYMPHONY ORCHESTRA, conducted by HOWARD CARR

EDWARD ISAACS (Solo Pianoforte)

Overture, 'The Hebrides' Mendelssohn

Selection from 'La Boutique Fantasque' ('The Eccentric Toyshop')

Rossini, arr. Respighi and Howard Carr

SOME light pieces, mostly for Piano, were practically all that Rossini composed in the second half of his life. Respighi, one of Rossini's countrymen of a later day, put some of these together and made them into the music for the piece called *The Eccentric Toyshop*, with which the Russian Ballet has so often delighted us.

The dolls in a toyshop come to life at night, and dance—Cossack Dances, the Polish Mazurka, an Italian Tarantella, a Waltz, and other charming steps.

EDWARD ISAACS and Orchestra

Concerto—First Movement Schumann

ORCHESTRA

Cavatina Raff

Gopak Moussorgsky

EDWARD ISAACS

Two Concert Studies, in F Minor Chopin

The Spinning Maid (La Fileuse) Raff

Rigaudon)

ORCHESTRA

Allegretto Grazioso (Second Symphony in D)

Brahms

Overture to 'William Tell' Rossini

10.45-12.0 DANCE MUSIC
KETTNER'S FIVE, under the direction of GEOFFREY GELDER, from Kettner's Restaurant

5XX DAVENTRY. 1,600 M.

10.30 a.m. Time Signal, Weather Forecast

11.0 TIME SIGNAL, BIG BEN.
THE DAVENTRY QUARTET and BLODWEN CAERLEON (Contralto); TOMMY SANDLANDS (Tebor); MIDDLETON WOODS (Energizer)

1.0-2.0 S.B. from London

2.55 S.B. from London

7.25 Prof. P. J. NOEL BAKER: 'Foreign Affairs and How They Affect Us—(VI) The Outlook for the Future.' S.B. from Birmingham

7.45 S.B. from London

9.10 Shipping Forecast

9.15 The Dinner of THE WORCESTERSHIRE ASSOCIATION
Relayed from the Hotel Victoria
Mr. D. COTES-FREEDY, K.C., proposing the Toast of the Prime Minister

9.20 Speech by THE PRIME MINISTER

9.50 Sir H. WALFORD DAVIES, 'Beethoven' (VI)

10.10-12.0 S.B. from London

Selected by Ballot!

Mr. J. H. Reyner
B.Sc. (Hons.), A.M.I.E.E.,

has constructed a set, the

"A.W. BALLOT 3"

based on data taken from thousands of coupons submitted by readers of "AMATEUR WIRELESS" in a recent competition asking for information as to the most satisfactory circuits and components.

The "AMATEUR WIRELESS" BALLOT THREE is easy and inexpensive to make.

A Free "Foldagraph"

being a combined Blueprint and Constructional Guide, giving a full-size layout and explicit instructions for the construction of the set, is given

with this week's

Amateur Wireless

A BUMPER ISSUE

containing article by Capt. Round, M.C., M.I.E.E., in which he suggests the construction of four giant broadcast stations for Gt. Britain.

On Sale To-day - 3^d.

PROGRAMMES FOR TUESDAY (February 22)

(Continued from page 371.)

5IT BIRMINGHAM. 326.1 M.

3.45 BROADCAST TO SCHOOLS: Mr. H. G. SEAR, 'The Man Behind the Music—Jovial Bach'

4.15 LOZELLS PICTURE HOUSE ORCHESTRA

4.45 B. J. FLETCHER, 'Landmarks in the History of Birmingham—The School of Art.' (The sixth of a Series of Talks arranged in connection with the Birmingham Library. MARY FREEMAN (Contralto))

5.15 THE CHILDREN'S HOUR: Fairy Story by PHYLLIS RICHARDSON. Songs by NORAH TARRANT (Contralto). Talk on French Folk Songs, with Illustrations, by ALICE CARRART

6.0 HAROLD TURLEY'S ORCHESTRA, relayed from Prince's Café

6.30 S.B. from London

7.0 Mr. C. G. BUTCHER: 'The Origin of Chess'

7.15 S.B. from London

7.25 Prof. P. J. NOEL BAKER—(VI) 'Foreign Affairs and How They Affect Us—The Outlook for the Future'

7.45 MILITARY BAND

THE CITY OF BIRMINGHAM POLICE BAND, conducted by RICHARD WASSSELL

'Homage' March Wagner
Overture to 'Egmont' Beethoven

WAGNER'S March (originally written for the Orchestra) was a tribute to King Ludwig of Bavaria, who was enthusiastic about the Composer's music, and helped him, in several very practical ways, to get his works on the stage. In 1864, the King and Wagner lived for a time together by Lake Starnberg, and Wagner's gratitude took this form.

THE Drama *Egmont*, to which Beethoven wrote music, is a treatment by Goethe of the story of the sixteenth-century struggle between the Netherlands and their Spanish oppressors. A statue of Count Egmont, hero of the Netherlands, who was beheaded by the Spaniards in the Grand Place of Brussels, now stands in the capital. Beethoven's music, particularly the Overture, is full of intense heroic feeling.

CHARLES DEAN (Baritone)

Oh, Could You But For One Short Hour

Sea Moods Tchaikovsky

The Wanderer's Song Catford

PERCY OWENS (Entertainer)

In Humorous Vein

BAND

Suite, 'Picturesque Scenes'

March; Ballet Air; Angelus; Gipsy Festival

WINIFRED PAYNE (Contralto)

O Peaceful England (Merrie England) German

An English Hearth Is Home Lohr

The Enchantress Hatton

BAND

Andantino Lemare, arr. Hoby

(Oboe: P. C. SAULL)

CHARLES DEAN

The Vagabond Molloy

Youth Allisen

The Fishermen of England ('The Rebel Maid')

Phillips

BAND

Kamarinskaja (Picture of a Russian Wedding)

Glinka, arr. Winterbottom

9.0 WEATHER FORECAST, NEWS; Local News

9.15 S.B. from Daventry

10.15 BAND

Ballet Suite, 'Coppélia' Delibes

PERCY OWENS

In Humour—not in vain

BAND

Scherzo in G Wassell

Farandole (Second 'Maid of Arles' Suite)

Bizet, arr. Dureau

10.45-12.0 S.B. from London

6BM BOURNEMOUTH. 491.8 M.

11.30-12.0 THE STATION TRIO: REGINALD S. MOUAT (Violin), THOMAS E. ILLINGWORTH (Cello), ERNEST LUSH (Pianoforte)

3.0 London Programme relayed from Daventry

4.0 TEA-TIME MUSIC by F. G. BACON'S ORCHESTRA, relayed from W. H. Smith and Son's Restaurant, The Square

5.0 London programme relayed from Daventry

5.15 THE CHILDREN'S HOUR

6.0 Musical Interlude

6.5 For Farmers: Mr. T. R. FERRIS, 'The Purchase and Mixing of Artificial Manures'

6.30 S.B. from London

7.0 HERBERT W. FISON (Retired Master Mariner): 'Sea Shanties of the Sixties'

7.15 S.B. from London

7.25 Prof. P. J. NOEL BAKER—(VI) 'The Outlook for the Future.' S.B. from Birmingham

7.45 MUSIC AND A SKETCH

THE STATION OCTET

Suite, 'Rustic Revels' Fletcher

Dancing on the Green; At Quality Court; All the Fun of the Fair

8.0 LAWRENCE BROUGH and OLGA ESME BROUGH

In a Humorous Interlude

8.10 OCTET

Galop, 'Express Train' Kalkbrenner

8.15 REMINISCENCES OF OPERA

OCTET

Selection from 'The Prodigal Son' Wormser

Selection from 'Il Trovatore' Verdi, arr. Tavan

ANDRÉ WORMSER, a French composer

(1851-1926) made a great success with

his musical play in dumb-show, *The Prodigal Son*. It is a modern, fanciful setting of an

old story.

Pierrot, for love of Phrynette, robs his parents

and flees with her. Disaster follows. Pierrot

comes down in the world, steals money for his

Phrynette, and comes home to find she has

gone off with a richer lover. Finally he returns

to his poor old broken-hearted parents and

enlists as a soldier to redeem his good name;

and so the curtain falls.

The music to this little drama is lyrically

charming and graceful.

8.45 S.B. from London (9.10 Local News)

9.35 BALLET MUSIC

THE STATION OCTET

La Source Delibes

Scar Dance; Love Scene; Variation; Circassian

Dance

9.50 MURIEL BARKAS (Soprano)

Who'll Buy My Lavender? German

O, Tell Me, Nightingale L. Lehmann

The Star J. Rogers

A Blackbird Singing M. Head

10.0 OCTET

Suite, 'The Two Pigeons' Messenger

Divertissement; Hungarian Dance; Finale

10.10 MURIEL BARKAS

The Rivulet Martin Shaw

I Heard a Piper Piping Arnold Bax

Barcarolle (with Violin Obligato) Offenbach

10.20 OCTET

Selection from 'The Queen of Sheba' Gounod

10.45-12.0 S.B. from London

PROGRAMMES FOR TUESDAY (February 22)

5WA CARDIFF. 353 M.

- 3.0 London Programme relayed from Daventry
- 3.45 THE STATION TRIO: FRANK THOMAS (Violin), FRANK WHITNALL (Violoncello), VERA McCOMB THOMAS (Pianoforte)
Selection from 'La Bohème' Puccini, arr. Alder
Valse Boston (Les Millions d'Arlequin)... Drigo
Episodes (Five Tone Pictures, Op. 72)... Schütt
- 4.30 TEA-TIME MUSIC from the Carlton Restaurant
- 4.45 Afternoon Topics
- 5.0 TEA-TIME MUSIC (Continued)
- 5.15 THE CHILDREN'S HOUR: THE TRIO
- 6.0 Capt. C. H. BREWER, M.C.: 'The History of the Aeroplane'



TO-NIGHT AT BIRMINGHAM.

A Military Band Concert will be broadcast from Birmingham to-night at 7.45. Mr. Richard Wassell (left) will conduct the City of Birmingham Police Band, and Mr. Charles Dean (right) will sing two groups of baritone songs.

6.10 A BEETHOVEN VIOLIN SONATA

Violin, LEONARD BUSFIELD
Pianoforte, VERA McCOMB THOMAS

OF Beethoven's ten Sonatas for Violin and Pianoforte scarcely any sustains so noble a discourse as this, the seventh (known as Op. 30, No. 2).

In its FIRST MOVEMENT there are some stormy episodes and some charming melodies, but dignity is never lost in passion.

The SECOND MOVEMENT, the slow one, is in a mood of elevated seriousness, to which the violin adds a note almost of melancholy. The long Coda which concludes the Movement has a new spirit of winsome charm.

The THIRD MOVEMENT provides the light relief that is now due. It is a perfect foil to the grave music that has come immediately before it.

The LAST MOVEMENT is one in which the inner drama of such non-pictorial music may be shaped by each hearer according to his liking. Broadly-moving tunes, active passage-work, and, in the middle of the Movement, a section in fugal style, all help to make up a Movement whose busy life is full of incident and effective effort.

6.30 S.B. from London

6.45 COMMUNITY SINGING

The Smoking Concert of the Students of the University College of S. Wales and Monmouthshire.

Professor CYRIL BRETT on 'The Students' Infirmary Week'

(Relayed from The Carlton Restaurant, Cardiff)

7.25 Prof. P. J. NOEL BAKER—(VI) 'The Outlook for the Future.' S.B. from Birmingham

7.45 THE WORKS OF FREDERICK HUMPHRIES

THE FREDERICK HUMPHRIES TRIO: TOM MATTHEWS (Violin), IRENE SARA (Violoncello), FREDERICK HUMPHRIES (Pianoforte)
Oriental Suite for Piano, Violin, and 'Cello.
'The Lute of Jade'

The Slumber Gardens of Laing; Pearl Pale Pavilions of Pleasure; The Dancers of the Yellow Dusk; Palanquins and Lanterns
Caprice
Berceuse

HILDA ROBERTS (Soprano)
Heigh Ho! For Daffodil Time
Off to Market, Johnny
I Remember

THE FREDERICK HUMPHRIES TRIO
Finale from Trio in C Minor (Allegro Furioso)
Six Miniatures for Piano, Violin, and 'Cello
Up With the Lark; The Lover's Nook; Wood Nymphs; An Eastern Song; My Lady's Bower; Torch Dance

9.0 S.B. from London (9.10 Local News)

9.35 THE WORKS OF FREDERICK HUMPHRIES (Continued)

THE STATION ORCHESTRA
Dramatic Overture, 'Richard III'
Idyll, 'Dreams of Yesterday' (Violin Solo)
(Solo Violin, LEONARD BUSFIELD)
Intermezzo, 'Serenade Lamentoso'

HILDA ROBERTS
Early One Morning
My Love is Like a Red, Red Rose
Love's Hour Glass

ORCHESTRA
Concert Overture in D Minor

10.15 HIDDEN TITLE PROGRAMME—II

A WELL-KNOWN MARCHING SONG

ORCHESTRA
Excerpts from 'Martial Moments'...arr. Winter
RONALD CHIVERS (Baritone)
Marching Through Georgia...Work
Tim the Dragoon...Stanford

ORCHESTRA
March, 'The B'hoys of Tipperary'...Amers
RONALD CHIVERS
When Johnny Comes Marching Home
Traditional
The Young Recruit...Kucken
ORCHESTRA
March, 'The Washington Post'...Sousa

10.45-12.0 S.B. from London

2ZY MANCHESTER. 384.6 M.

1.15-2.0 TUESDAY MIDDAY SOCIETY'S CONCERT, relayed from the Houldsworth Hall. Vocal Recital by DOROTHY ROBSON (Soprano)

3.0 London Programme relayed from Daventry

3.45 AFTERNOON MUSIC by the STATION QUARTET

4.15 BROADCAST TO SECONDARY SCHOOLS: Prof. F. E. WEISS, F.R.S.: 'The Romance of Plant Life—(VI) Ferns and Their Past History'

4.35 TEA-TIME MUSIC

THE STATION QUARTET
Russian Ballet...Luigini
THE HANA SISTERS (Entertainers)
Hoodle Dee Doo, Dee Doo Doo
Nobody's Business

QUARTET
The Grasshoppers' Dance...Bucalossi

HANA SISTERS
Lay Me Down to Sleep in Carolina
My Cutey's Due at Two to Two

QUARTET
Selection from 'A Country Girl'...Monckton

5.15 THE CHILDREN'S HOUR

6.0 THE MAJESTIC 'CELEBRITY' ORCHESTRA, from the Hotel Majestic, St. Anne's-on-the-Sea. Musical Director, GERALD W. BRIGHT

6.30 S.B. from London

6.45 THE MAJESTIC 'CELEBRITY' ORCHESTRA (Continued)

7.0 Dr. J. E. MYERS: 'The Use and Abuse of Fuel'

7.15 S.B. from London

7.25 Prof. P. J. NOEL BAKER—(VI) 'The Outlook for the Future.' S.B. from Birmingham

7.45 ROUND EUROPE

'Come and trip it as ye go
On the light fantastic toe'

THE AUGMENTED STATION ORCHESTRA

FRANCE
Ballet, 'The Two Pigeons'...Messenger

SPAIN
Spanish Ballet...Desotnes



Miss Muriel Barkas (left) will sing from Bournemouth Station at 9.50 and 10.10 to-night, and Miss Hilda Roberts (right) sings some soprano songs in the 'Frederick Humphries' Concert from Cardiff at 7.45.

ARTHUR SPENCER (Solo Pianoforte)
Danse du Meunier (Miller's Dance)...De Falla
Tango...Turina
Seguidillas...Albeniz

ITALY
ANNIE CHADWICK (Soprano)
Al Ballo...O. Scanzici

ORCHESTRA
Dance of the Hours ('La Gioconda') Ponchielli

BOHEMIA
ORCHESTRA
First and Second Slavonic Dances...Dvorak

9.0 S.B. from London (9.10 Local News)

9.35 ROUND EUROPE (Continued)

RUSSIA
ORCHESTRA
Dances from 'Prince Igor'...Borodin

SCOTLAND
ORCHESTRA
Harvest Dance...Hamish MacCunn

IRELAND
ANNIE CHADWICK
Dancing Time in Kerry...Hampson
In the Gay Olden Time (Gigue)...Phillips

ORCHESTRA
Four Irish Dances...Stanford

ARTHUR SPENCER
A Slow Dance...Stanford, arr. Grainger
Irish Reel, Molly on the Shore...Grainger

WALES
ORCHESTRA
Ap Siencyn...
Codrad ye Haul...arr. Myddleton
Hela'r 'sgywarbog

ENGLAND
ORCHESTRA
Four English Dances...Cowen

10.45-12.0 S.B. from London

PROGRAMMES FOR TUESDAY (February 22)

5KH HULL. 294 M.

- 4.0 AFTERNOON TOPICS: Mrs. J. REDWOOD ANDERSON, 'Art Through the Ages—(VI) Dutch, Flemish, German Painting'
- 4.15 FIELD'S QUARTET, relayed from the New Restaurant, King Edward Street
- 5.15 THE CHILDREN'S HOUR: Radiosities Competition
- 6.0 London Programme relayed from Daventry
- 6.15 Hull Wireless Society's Talk
- 6.30 S.B. from London
- 7.25 S.B. from Birmingham
- 7.45 S.B. from London (9.10 Local News)
- 9.35 POPULAR VOCAL AND INSTRUMENTAL
- BESSIE WEBSTER (Soprano)
- Le Portrait Beatrice Parkyn
In Summertime on Bredon Graham Peel
When May Bells Ring Ernest Newton
- 9.45 MARION DE BOER and KITTY ASPIN (PIANO-FORTE DUETS)
- Fantaisie Schubert
- 9.55 FRED TODD (Bass)
- The Ladies of St. James's Reginald Clarke
Leanin' Sterndale Bennett
On the Safe Side Easthope Martin
- 10.5 GEORGE WILBY (Entertainer)
In Selections from his Repertoire
- 10.15 ERNEST WILLIS (Tenor)
- Ave Maria Mascagni
One Little Hour Evelyn Sharpe
All Hail, Thou Dwelling Gounod
- 10.25 MARION DE BOER and KITTY ASPIN
- Allegro Brillante Mendelssohn
- 10.35 'THE POLICEMAN'S SERENADE'
An Operetta by A. P. Herbert and Alfred Reynolds
Presented by:
- BESSIE WEBSTER (Soprano), ERNEST WILLIS (Tenor), GEORGE WILBY (Baritone), and FRED TODD (Bass)
- 11.0-12.0 S.B. from London

2LS LEEDS-BRADFORD. 277.8 M. & 252.1 M.

- 4.0 WYNN and ALLAN'S ALL STAR VERSATILES, relayed from Schofield's Café, Leeds
- 5.0 AFTERNOON TOPICS
- 5.15 THE CHILDREN'S HOUR
- 6.0 LIGHT MUSIC
- 6.30 S.B. from London
- 7.25 S.B. from Birmingham
- 7.45-12.0 S.B. from London (9.10 Local News)

6LV LIVERPOOL. 297 M.

- 4.0 GAILLARD and his ORCHESTRA, from the Scala Cinema
- 5.0 Talk for Women by MURIEL LEVY
- 5.15 THE CHILDREN'S HOUR: Music by THE PIANO-FORTE QUARTET
- 6.0 THE STATION PIANO-FORTE QUARTET
- 6.30 S.B. from London
- 7.0 Mr. ERNEST EDWARDS ('Bee'): Weekly Sports Talk

- 7.15 S.B. from London
- 7.25 S.B. from Birmingham
- 7.45-12.0 S.B. from London (9.10 Local News)

5NG NOTTINGHAM. 275.2 M.

- 11.30-12.30 Morning Concert relayed from Daventry
- 3.45 LYONS' CAFÉ ORCHESTRA, conducted by BRASSEY EYTON
- 4.45 MUSIC and AFTERNOON TOPICS: Miss BOTT 'Shopping in India'
- 5.15 THE CHILDREN'S HOUR
- 6.15 MABEL HODGKINSON (Pianoforte)
- 6.30 S.B. from London
- 7.0 Mr. F. H. HEALD: 'Our Lakes'
- 7.15 S.B. from London
- 7.25 S.B. from Birmingham
- 7.45 S.B. from Sheffield
- 8.45-12.0 S.B. from London (9.10 Local News)

5PY PLYMOUTH. 400 M.

- 11.0-12.0 GEORGE EAST and his QUARTET, relayed from Popham's Restaurant
- 3.30 ORCHESTRA relayed from Popham's Restaurant
- 4.0 AFTERNOON TOPICS: Miss M. P. WILLCOCKS, 'The Cradle Song as a New Form of Drama'
- 4.15 TEA-TIME MUSIC: THE ROYAL HOTEL TRIO, directed by ALBERT FULLBROOK
- 5.15 THE CHILDREN'S HOUR
- 6.0 GLADYS STONE (Soprano)
- 6.30 S.B. from London
- 7.0 Mr. H. G. TAYLOR: 'Pike Fishing'
- 7.15 S.B. from London
- 7.25 S.B. from Birmingham
- 7.45-12.0 S.B. from London (9.10 Local News)

'ON TOUR' THIS WEEK.



Meet Miss Doris Palmer, one of the most original comedienne who ever confided her sad story to Mr. Mike! Her 'make-up' as a weebegone Cockney slavey is as familiar to the vaudeville 'fans' as George Robey's eyebrows and Sir Harry's twisted walking-stick. Doris has hit the high places in Vaudeville, Musical Comedy, and Concert Party. She was early drawn into the great maelstrom of theatre life: at the tender age of six she played 'King of the Glow-Worms' in a pantomime during her Christmas holidays!

These are her dates this week. Be sure to hear her when she comes on to your wavelength.

Monday, Manchester; Tuesday, Aberdeen; Thursday, Glasgow and Belfast; Friday, Birmingham; Saturday, Cardiff.

6FL SHEFFIELD. 272.7 M.

- 4.0 AFTERNOON TOPICS: Miss M. MAXFIELD: 'Mentally and Physically Defective Children Under the Care of the Education Committee'
- 4.15 London Programme relayed from Daventry
- 5.15 THE CHILDREN'S HOUR
- 6.0 Musical Interlude
- 6.30 S.B. from London
- 7.0 Sir WILLIAM E. HART, the Town Clerk: 'How Sheffield's City Departments Work' (5)
- 7.15 S.B. from London
- 7.25 S.B. from Birmingham
- 7.45 AN HOUR OF VARIETY
FRANK SAYER'S ESCAFIAN BAND
Fox-trot, 'Moonlight on the Ganges'
Sherman Myers
- 7.50 CISSIE FAIREST (Entertainer at the Piano)
Laugh Original
Castles in the Air M. Broughton
- 7.56 BAND
Comedy Fox-trot, 'Hard To Get Gertie'
Milton Ager
- 8.2 DAVID MILNER (Banjo) and GEORGE JEFFERSON (Pianoforte)
Hark, Hark, the Lark (Unaccompanied)
Schubert
Bolero Cammeyer
My Old Kentucky Home (Unaccompanied)
Foster
- 8.12 BAND
Comedy Fox-trot, 'Let's Talk About My Sweetie' W. Donaldson
Waltz, 'Dreaming of Brown Eyes'
Marcelle Mayne
- 8.21 CISSIE FAIREST
Billy David Kemp
The Noble Duke of York Graham Squires
- 8.31 BAND
Comedy Fox-trot, 'I Wonder What's Become of Joe?' Marcio Pinkard
Trumpet Solo, 'Ida I do' Isham Jones
- 8.36 DAVID MILNER
Danse Bizarre }
En Passant .. } Cammeyer
In Honeyland }
- 8.42 BAND
Fox-trot, 'Black Bottom' Ray Henderson
- 8.45 S.B. from London (9.10 Local News)

- 9.35 GRAND OPERA CONCERT
Arranged by the SHEFFIELD AND DISTRICT GRAND OPERA SOCIETY. BOOTH UNWIN, MABEL NORTON and HAROLD JOLLY
- Recit. ('Mephistopheles') 'It Was High Time' (Act III, 'Faust') Gounod
- IN the recitative Mephistopheles calls on the powers of darkness to infatuate the senses of Faust and Margarita, and so to aid him in his plot against the soul of Faust.
- In the Duet Margarita, now that the hour grows late, would bid Faust adieu, but he pleads his love the more passionately, and persuades her to stay.
- MABEL NORTON and HAROLD JOLLY
Last Finale from 'Aida' Verdi
- 9.47 JOHN ROBERTS
Solo and Cavatina (Valentine), 'Dear Gift of My Sister' (Act II, 'Faust') Gounod
- 9.52 MABEL BAKER
Cavatina (Leonora) (Act I, 'Il Trovatore') .. Verdi
- 9.57 GEORGE BIGGINS
Solos: (Wolfram)—
Gazing Around This Fair }
Assembly (Act II) } ('Tannhäuser')
Oh Star of Eve (Act III, }
Scene 2) } Wagner

PROGRAMMES FOR TUESDAY (February 22)

10.6 GEORGE LAWTON and BOOTH UNWIN
 Recit., 'If I Pray There is None to Hear' } (Act I, Scene 2,
 Duet (Faust and Mephistopheles), 'Be Mine the Delight' } 'Faust') Gounod

10.15 ELEANOR KNIGHT (Violin)
 Solo, Romance, Op. 26 Scendson

10.21 FREDERICK BRINDLEY
 Prologue (Tonio) ('I Pagliacci') .. *Leoncavallo*
 CYRIL WOLSTENHOLME
 Air (Canio), 'On With the Motley' (Act I, 'I Pagliacci') *Leoncavallo*

10.28 NELLY CLOSS, MABEL BAKER, CYRIL WOLSTENHOLME
 Duet and Scene (Manrico and Azucena) (Manrico and Leonora), 'Home to Our Mountains' ('Il Trovatore') *Verdi*

10.37 FREDERICK BRINDLEY
 Solo, 'Toreador Song' ('Carmen') *Bizet*

10.41 ELEANOR KNIGHT
 Serenata *Toselli*

10.45 CONSTANCE TURLE
 Recital, 'Juliet and the Nurse' .. *Shakespeare*

10.50 GERTRUDE GILPIN and GEORGE LAWTON
 Scene between Amneris and Radames (Opening of Act IV, 'Aida') *Verdi*
 MARY HELLIWELL, Accompanist

11.0-12.0 S.B. from London

6ST **STOKE.** **294 M.**

12.0-1.0 THE STATION QUARTET
3.0 London Programme relayed from Daventry
5.0 AFTERNOON TOPICS: Mr. B. T. ABELL, 'The Ant'
5.15 THE CHILDREN'S HOUR
6.0 LEON FORRESTER (Pianoforte Recital)
6.30 S.B. from London
7.0 Mr. FRANK LAMBERT: 'England Before the Angles'
7.15 S.B. from London
7.25 S.B. from Birmingham
7.45 S.B. from Cardiff
9.0 S.B. from London **9.10** Local News
9.35 **IRISH NIGHT**

Described by E. SIMS-HILDITCH

ANNIE ELLISON (Soprano); DOROTHY LEDSUME (Contralto); JOHN ROBERTS (Tenor) and HARRY VERNON (Baritone)

HARRY VERNON
 The Harp That Once Through Tara's Halls *arr. Stewart*

F. CHRISTIAN ORFORD (Violin)
 Irish Lament *arr. Schofield*
 Killarney *arr. Stresa*

JOHN ROBERTS
 Oft In the Stilly Night *Irish Air*
 Come Back to Erin *Claribel*

DOROTHY LEDSUME
 The Little Red Lark } *Old Irish*
 Avenging and Bright }

HARRY VERNON
 The Gentle Maiden *Old Air*
 She is Far from the Land *Lambert*

ANNIE ELLISON
 I Found My Bonnie Babe a Nest *Irish*
 Kathleen Mavourneen *Crouch*

JOHN ROBERTS and HARRY VERNON
 The Moon Hath Raised *Benedict*

E. CHRISTIAN ORFORD
 Irish Airs *arr. John Larchet*

ANNIE ELLISON, DOROTHY LEDSUME, JOHN ROBERTS and HARRY VERNON
 The Dear Little Shamrock *Irish Air*
 JOHN ROBERTS
 The Minstrel Boy *The Morcen*
 DOROTHY LEDSUME
 Danny Boy *Old Irish Melody*
 HARRY VERNON
 The Irish Emigrant *Barker*
 ANNIE ELLISON
 Killarney *Balfe*
 ANNIE ELLISON, DOROTHY LEDSUME, JOHN ROBERTS and HARRY VERNON
 'Tis the Last Rose of Summer *arr. Stewart*

11.0-12.0 S.B. from London

5SX **SWANSEA.** **294 M.**

11.30-12.30 Gramophone Records
3.0 London Programme relayed from Daventry
3.45 THE CASTLE CINEMA ORCHESTRA and ORGAN MUSIC relayed from the Castle Cinema
4.30 THE STATION TRIO: T. D. JONES (Pianoforte); MORGAN LLOYD (Violin); GWILYM THOMAS (Cello)
5.15 THE CHILDREN'S HOUR
6.0 A Short Violin Recital by PEGGI WHITMAN
 Allegro Maestoso (Tempo di Marcia), Op. 11 from Concerto Héroïque *François Prume*
 Love's Pleading (Plainte d'Amour) *Bruce Steane*
 Passione *Ranzato*
6.30 S.B. from London
7.0 Mr. R. P. AUSTIN, 'Adventures of an Archaeologist in Greece—Greek Brigands, Ancient and Modern'

7.15 S.B. from London
7.25 S.B. from Birmingham
7.45 THE PENCLAWDD ORPHEUS MALE VOICE CHOIR, conducted by W. JENKINS
 Call John } *Macy*
 Little Tommy }
 D. J. JENKINS (Tenor)
 O Flower of All the World .. *Woodforde-Finden*
 CHOIR
 The Anvil *Adams*
 H. LEWIS (Baritone)
 There's a Turn in Every Tide *De Luca*
 CHOIR
 All Will Be Well *W. Jenkins*
 Peace Be Still *D. Jenkins*
 T. J. EYNON (Tenor)
 Sigh No More, Ladies *Aiken*
 W. G. JENKINS (Pianoforte)
 Dawn *Grike*
 Luten *Beringer*
 W. GUY (Bass)
 Chwyfrion Faner *W. Davies*
 CHOIR
 Robin Adair *arr. Lewis*
 Invictus *Protheroe*

8.30 PEGGI WHITMAN (Violin)
 Farfalla, Op. 40 *Sauret*
 Extase d'Amour, Op. 28. *Raymond Rose*
 Marche-en-Rondeau (Transcription of a Manuscript) *Saint George*

8.45-12.0 S.B. from London (**9.10** Local News)
 (Tuesday's Northern Programmes in summary form appear in column 2, page 379.)

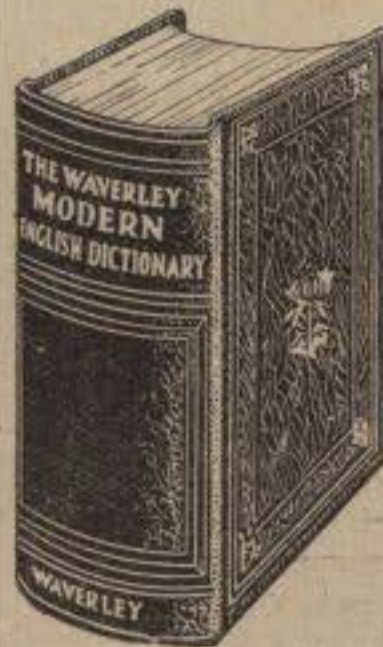

The New Dictionary with the New Features

Up-to-Date — Just Off the Press.

EXCLUSIVE FEATURES:

Separate Lists of Difficult Words often mis-spelt or mispronounced. — Full List of Wireless Terms.

Other Prominent Features are Lists of
 Synonyms and Antonyms | Commercial Terms
 Foreign Words and Phrases | Characters in Prose and Poetry
 Sports Terms | Pen-Names of Authors

INVALUABLE TO THE STUDENT.

To the student up to date information is of vital importance. The educated do not consult a dictionary in order to look up every-day words, and only occasionally are they interested in the older or practically obsolete words. It is the newer nomenclature in the scientific, artistic, or literary realms in which they are more likely to be interested.

It is the up-to-the-moment character of the Waverley Modern Dictionary which will appeal to such people.

Again the Waverley List of Synonyms and Antonyms will be found extremely useful to those who do not possess a separate and exhaustive Thesaurus.

FREE Illustrated Prospectus awaits you. Let us tell you more about this splendid work, and our very easy terms.

MOST HELPFUL TO CROSS-WORD ENTHUSIASTS.

The very features which make the Waverley Dictionary so valuable to the student constitute its great appeal to the Cross-word solutionist.

On a recent occasion it was found that all the words forming the winning solutions in twelve puzzles (taken haphazard from current publications) were contained in the New Waverley Dictionary.

THE WAVERLEY BOOK CO., LTD. (Dept. R.T.E.)
 96 & 97, Farringdon Street, London, E.C.4.

Please send me your Free Illustrated Prospectus with particulars of 'The Waverley Modern English Dictionary,' also information as to your offer to send the book for a nominal first payment.

NAME
(Send this form in envelope with 1d. stamp.)
 ADDRESS
 R.T.E. 1927.

PROGRAMMES FOR WEDNESDAY (February 23)

ZLO LONDON. 361.4 M.

(1.0 Time Signal, Big Ben)

1.0-2.0 CAMILLE COUTURIER'S ORCHESTRA, from Restaurant Fruscati

3.0 Mr. A. LLOYD-JAMES, 'Our Native Tongue'

MR. LLOYD JAMES, who is giving this series of Talks, was secretary to the B.B.C.'s Advisory Committee on Spoken English.

2.55 Reading, 'Pickwick Papers,' by Charles Dickens

3.20 Mr. J. C. STOBART and Miss MARY SOMERVILLE, in their series on 'Some Books Worth Reading,' come this week to the Odyssey

IT would be hard to compute the number of adventure stories that have seen the light in the three thousand years since Homer (or, if research proves it not to have been Homer, whoever was their author) composed the 'Iliad' and the 'Odyssey.' Yet it is doubtful whether the Odyssey has ever been excelled as an adventure story, apart from any other aspect. The strange voyage of Odysseus on his way home from Troy after the siege, to his island kingdom of Ithaca, has provided the standard term for such romantic journeys.

3.45 Miss RHODA POWER, 'Village Life 100 Years Ago'

MISS RHODA POWER concludes her series of talks with a picture of rural life a hundred years ago, which makes but a sorry comparison with the healthy medieval community with which she began. In the early nineteenth century the very improvements in agricultural technique had caused great dislocation and distress; prices had risen out of sight of wages, and the villager who eked out his rations by poaching encountered the inhuman severity of the Game Laws; the Napoleonic wars drained off many breadwinners by the medium of the press-gang; home industries were dying in face of the Industrial Revolution, and the countryside was being depopulated. The first railways are almost the only bright feature of the depressing scene.

4.0 TIME SIGNAL, GREENWICH. THE DAVENTRY QUARTET and KATHLEEN DE STOURNEL (Soprano); DAISY SCOTT (Flute)

5.15 THE CHILDREN'S HOUR: 'The Toy Symphony' (conducted by STANFORD ROBINSON). Verses from 'Pillcock Hill' (Herbert Asquith). 'A Visit to a Lightship' (G. G. Jackson)

6.0 ORGAN RECITAL by REGINALD FOORT, relayed from the New Gallery Kinema

6.20 The Week's Work in the Garden, by the Royal Horticultural Society

6.30 TIME SIGNAL, GREENWICH; WEATHER FORECAST, FIRST GENERAL NEWS BULLETIN

6.45 ORGAN RECITAL by REGINALD FOORT (Continued)

7.0 Air Ministry Talk: Major H. HEMMING, 'Air Survey'

WE all know something about aerial survey, and most of us have seen remarkable aerial photographs of towns, but the sort of survey that Major Hemming—the well-known pilot, now Managing Director of the Aircraft Operating Company—will describe this evening is a new and most important development. The plan is for the airman and mining engineer, working in co-operation, to look for copper in the jungle of Northern Rhodesia. Flying over the jungle at a height of some two and three-quarter miles, the airman will take a series of photographs. These will be studied by the geologists, who will be able to tell where copper lies near the surface, owing to its effect on the vegetation. Parts of the area

will then be mapped from the air, and altogether some 20,000 square miles of dense jungle will be surveyed.

7.15 SCHUMANN'S 'MYRTLES'
Sung by DALE SMITH

THE song-cycle *Myrthen* (*Myrtles*—the ancient symbol of youth and beauty) was an offering to Schumann's beloved Clara Wieck.

The songs are not all on one topic. Schumann for this cycle took poems by Heine, Goethe, Burns, Byron, Moore and others.

To-night we are to hear the first six of the twenty-six songs in the cycle.

I. *Widmung* (*Dedication*). This setting of words by Rückert is one of the most frequently sung of all Schumann's songs. It is a fine, stirring love-song. 'Thou art my soul, . . . my world, . . . my heaven, . . . my guardian saint, my better self,' is its fervent declaration.



MAKING MAPS FROM THE AIR.

This picture illustrates the method of aerial survey of which Major Hemming will talk to-night [London 7.0]. A series of overlapping photographs is taken by the automatic camera seen behind the photographer, and the whole of the area to be mapped is covered by successive parallel flights. The photographs are then joined together in the form of a picture map, or mosaic.

II. *Freisinn* (*Liberty*). Goethe's poem speaks of the bracing joys of the free mind, whose master rides boldly abroad, raising his eyes aloft to behold wonders, while the dullards stay in their huts.

III. *Der Nussbaum* (*The Hazel Tree*). Words by Julius Moser. A graceful suggestion of the hazel tree, bending to the light winds, its blossoms swaying together as though kissing. They whisper of a maid who wanders through the wood; never telling her thoughts. What is she thinking about? Perhaps the leaves can guess; they whisper hints of a bridegroom for next year. With such a thought in her mind the maiden sinks sweetly to sleep.

IV. *Jemand* (*Somebody*). Here Schumann came to Burns for his words. 'Somebody,' who is absent, is causing a maiden anxiety, and she begs the powers that smile upon love to protect her man and send him safely back to her.

V. *Sitz' ich allein* (*I sit alone*). The next two songs, fragments from Goethe, sing of vinous joys. In the first the poet imagines a contented person sitting by himself, drinking his wine, and so pleased, with his own thoughts for company, that

he wants no better enjoyment. To this thought Schumann has put a cheery tune.

VI. *Setz mir nicht* (*Place not the jug*). This is just a jolly couple of stanzas in praise of the cheering liquor.

7.25 Prof. V. H. MOTTRAM, 'Present Day Problems of Food: (6) False and True Economy in Food'

PROFESSOR MOTTRAM, the author of 'Food and the Family,' concludes his series of talks on the scientific aspect of food by some very useful advice on 'Economy in Food.' Many careful housewives, with every desire to be economical, waste money because of an antiquated belief that certain standard foods—usually the expensive ones—are more nutritive than certain others—usually the cheap ones. How many readers, for instance, are aware of the comparative food values of eggs, steak and herring, in proportion to their price?

7.45 AN HOUR OF VARIETY

SCOVELL AND WHELDON
(Syncopated Duets)
FLORENCE MARKS
(Irish Humour)
SYLVESTER LEON
(In a Jamaican Character Study)
MARIO DE PIETRO
(on the Banjo)
JANET JOYK
(Impersonations)

8.45 THE SALISBURY SINGERS
Down in a Flow'ry Vale Festa
I Loved a Lass Reay
Go, Rose Beale
Fair Phyllis I Saw John Farmer

9.0 TIME SIGNAL, GREENWICH; WEATHER FORECAST, SECOND GENERAL NEWS BULLETIN; Local Announcements

9.15 An Antique Instrument Lecture. Recital by Dr. GEORGE DYSON, S.B. from Liverpool

9.45-11.0 'TRILBY'
(See Special Programme on next page)

5XX DAVENTRY. 1,600 M.

10.30 a.m. Time Signal, Weather Forecast

11.0 TIME SIGNAL, BIG BEN
THE DAVENTRY QUARTET, with Viola RITA MATTEI (Soprano); KENNEDY ARUNDEL (Baritone); GERARD MOORATT (Pianoforte)

11.45 app. Recital of Old English Songs and Duets by EVA NEALE and Miss MONICA MARLOR

Duet
It was a Lover and his Lass Waltham

Solos by EVA NEALE
The Lass of Richmond Hill
My Lodging Is In the Cold Ground
The Oak and the Ash
Love was Once a Little Boy

Duet
I Know a Bank Shaw

12.5 CONCERT (Continued)

1.0-2.0 S.B. from London

2.55 S.B. from London

9.10 Shipping Forecast

9.15 S.B. from Liverpool

9.45 S.B. from London

11.0-12.0 DANCE MUSIC: ALFREDO and his BAND and NEW PRINCES' DANCE BAND, from the New Princes' Restaurant

(Continued on page 378.)

Trilby Comes to the Microphone.

A Best Seller of the 'Nineties.

By Stephen Graham.

THE success of 'Trilby' came on a rebound from America, like 'If Winter Comes' in our days. It was published in *Harper's Magazine*, following 'Peter Ibbetson.' The year was 1894, incidentally that of Stevenson's death. 'The taste for it became a passion, the passion became a mania, the mania became a madness,' wrote Huntly McCarthy. It was exalted into a sort of Bible and preached on from every pulpit and discussed by every society. In England its popularity became as great as in America, and the literary appreciation of it was perhaps more solid. 'Trilby' was most commonly compared with the work of Thackeray. One critic felicitously called Du Maurier 'a sweeter Thackeray—a Thackeray without the bitter-sweet.'



One of Du Maurier's characteristic drawings showing Trilby with her three friends: the Laird, whose hand she is holding; Taffy, the big Welshman, and Little Billy.

The success was, however, due more to the romantic and sentimental interest of the novel than to its style. It was, moreover, the first veritable picture of modern Bohemian life. It also made and fed an appetite for knowledge about hypnotism and about the intimate life of the artist's model.

Again, several of the characters in 'Trilby' were drawn from life, and that added to the piquancy of the interest. The humorous incidents were common talk of Du Maurier before he wrote them down, and they were mostly derived from his own life in the Quartier Latin of Paris. Also, Du Maurier, greater as an artist than as a writer, was able to stimulate the general interest in his novel by his wonderful drawings. In fact, there were very many features contributing to make the 'Trilby' boom. The last comment on these features must be that the picture and character of Trilby herself made the greatest appeal.

Trilby was utterly charming and lovable—she posed for 'the altogether.' Men and women repeated it in a hushed voice—the altogether. Trilby's naked feet introduced a new permanent word into our slang—almost into our language. Was not Dorothea Baird, who played the part, the first prominent actress to show her bare feet on the stage! We have travelled somewhat from the 'nineties to the days of the Russian ballet, have we not?

Du Maurier was the successor of John Leech on *Punch*. He was a one-eyed man, and the sight of the one eye was failing him. He was afraid that



Miss PHYLLIS NEILSON-TERRY,

'the singing Trilby,' who has made her own the part created by Dorothea Baird, which she will take in to-night's performance.

'TRILBY'

A Play Taken from George Du Maurier's Novel.

Arranged for Broadcasting.

Characters:

Svengali..... ERNEST MILTON
 Talbot Wynne ('Taffy') .. ERNEST G. COVE
 Alexander McAlister (The Laird)
 DOUGLAS JEFFERIES
 William Bagot ('Little Billy')
 JAMES BAGLAN
 Gecko CYRIL NASH
 Rev. Thomas Bagot .. VINCENT STERNBOYD
 Dorlor GEORGE HOWE
 Zouzou..... DINO GALVANI
 Antony..... ARTHUR BLANCH
 Lorimer..... ROGER MAXWELL
 Manager Kaw B. A. PITTAR
 Mrs. Bagot YVETTE PIENNE
 Madame Vinard EILEEN MUNBO
 Trilby O'Ferrall

PHYLLIS NEILSON-TERRY

ACT I. A Studio in Paris. The walls are covered with plaster-casts, studies in oils, foils, masks and boxing-gloves. Three easels are in different parts of the room and a model throne occupies the centre. There is an alcove containing a piano. Through a large bay-window at the back of the studio a church can be seen with a glimpse of the River Seine in the distance.

ACT II. The same room, decorated with holly and greenery and well-lighted, at nine o'clock on Christmas Eve. A dinner-party is in progress in an adjoining room. The church across the way is illuminated.

ACT III. The Foyer of the Cirque de Bashibazouks. It is a handsome room, draped and decorated. In the theatre itself an opera is in progress.



Mr. ERNEST MILTON

has played with conspicuous success in parts ranging from Shylock to Romeo, but in this performance he will portray one of the most tremendous and pathetic villains who ever walked the boards.

owing to his defective eyesight he would not be able to continue drawing, and that he might become destitute. So he took to novel writing in order to safeguard his future. He illustrated and told the story of 'Peter Ibbetson' for *Harpers*. It succeeded fairly, and he was commissioned to write a second novel. That second novel was 'Trilby.' Needless to say, it put himself and his family out of all danger of poverty. It was one of the great best-sellers, and the play which followed, with Beerbohm Tree as Svengali, was as great a success as the novel. A leading London bookseller tells me that even to-day there is a steady sale of 'Trilby.'

The famous actor-son of George Du Maurier played in *Trilby* when it was produced at the Haymarket in the autumn of 1895. Sir Gerald Du Maurier remarks: 'Father never thought that *Trilby* would be a success as a play... he said he didn't care what was done with it as long as he was not obliged to see it... But he



The sinister Svengali teaching Trilby to sing. The two drawings by Du Maurier on this page are reproduced here by permission of the Executors of the Du Maurier estate, and of Harper Brothers, the publishers of the book.

changed his mind about it later and thought it awfully clever to be able to make a play out of it at all.' The Gerald Du Maurier of those days had but a minor part to play, but no doubt his father's dramatized novel was an inspiration to him in his career. And Svengali, I suppose, was almost the most important and striking rôle in the career of the late Beerbohm Tree.

It is said that Du Maurier himself always remained very modest about his work. He did not think it great just because so many praised it and all the world was reading it. On the contrary, his artistic conscience was somewhat shocked that his 'pot-boiler' was being compared to the best of Thackeray. He was very like Thackeray in some respects. Both writers were artists before they were novelists. Both illustrated their own novels. The judgment of posterity is, however, clear: Du Maurier was a greater artist than Thackeray. As Henry James said, 'No artistic novel (in his generation) has been more exquisite in quality.' And after all, the author of 'Vanity Fair' was greater than the author of 'Trilby.' Du Maurier knew that, and he used to remark whimsically, 'Thackeray never had a boom,' by which he meant modestly to imply that if a man really wrote a work of genius, it would be unlikely to be appreciated by the masses. Hardy's great book, 'Tess,' which appeared two years after 'Trilby,' had to wait a long while for its boom—perhaps till now.

PROGRAMMES FOR WEDNESDAY (February 23)

(Continued from page 376.)

5IT BIRMINGHAM. 326.1 M.

- 3.45 London Programme relayed from Daventry
- 4.0 THE STATION WIND QUINTET
ERIC HUXLEY (Violin)
Rondo *de Beriot*
Conzonetta *d' Ambrosio*
First Hungarian Rhapsody *Liszt, arr. Henley*
- 4.45 AFTERNOON TOPICS: KATHERINE CONSTABLE,
'The Slum Child at School' MARGARITE VARDY
(Pianoforte)
- 5.15 THE CHILDREN'S HOUR
- 6.0 LOZELLS PICTURE HOUSE ORCHESTRA, con-
ducted by PAUL RIDMER
- 6.20 *S.B. from London (9.10 Local News)*
- 9.15 *S.B. from Liverpool*
- 9.45-11.0 *S.B. from London*

6BM BOURNEMOUTH. 491.8 M.

- 3.0 London Programme relayed from Daventry
- 4.0 AN AFTERNOON CONCERT
THE STATION OCTET
March, 'Florentiner' *Fuck*
Valse, 'Moonlight on the Rhine' *Vollstedt*
Entr'acte, 'Ke-Sa-Ko' *Chapuis*
- 4.20 JEANE PAULE and LEONIE LASCELLES
introduce a Piano and Themselves
in Harmony, Syncopation and Comedy Duets
- 4.30 REGINALD H. WHITTAM (Violin)
Nocturne in E Flat. . . . *Chopin, arr. Sarasate*
- 4.35 OCTET
Suite, 'Spanish Suite' *Leoncavallo*
Sevillana; Tango; Granadinas
- 4.50 JEANE PAULE and LEONIE LASCELLES
In Harmony, Syncopation and Comedy Duets
- 5.0 REGINALD H. WHITTAM
Poem *Fibich, cd. Kubelik*
Mazurka *Mlynarski*
- 5.5 OCTET
Two Pieces *Tchaikovsky*
Rêverie; Danse Russe
- 5.15 THE CHILDREN'S HOUR
- 6.0 Gramophone Records
- 6.20 *S.B. from London (9.10 Local News)*
- 9.15 *S.B. from Liverpool*
- 9.45-11.0 *S.B. from London*

5WA CARDIFF. 353 M.

- 3.0 London Programme relayed from Daventry
- 4.0 THE DANSANT: Music by THE LONDON
CHORDEANS, relayed from Cox's Café
- 4.45 Miss DOROTHY MORTON, 'How to Right the
Wrong'
- 5.0 THE DANSANT: Music by THE LONDON
CHORDEANS, relayed from Cox's Café
- 5.15 THE CHILDREN'S HOUR
- 6.0 Mr. B. PERROTT, 'Our Distant Neighbours in
Space'
- 6.15 Light Music
- 6.20 *S.B. from London (9.10 Local News)*

- 9.15 *S.B. from Liverpool*
- 9.45-11.0 *S.B. from London*

2ZY MANCHESTER. 384.6 M.

- 3.0 London Programme relayed from Daventry
- 4.0 TEA-TIME CONCERT: ORCHESTRAL MUSIC
from the Piccadilly Picture Theatre
- 5.0 Mr. PERCEVAL GRAVES: A Talk on Opera
with Gramophone Illustrations
- 5.15 THE CHILDREN'S HOUR: 'An Afternoon with
Samuel Pepys'
- 6.0 LIGHT MUSIC by the STATION QUARTET
- 6.20 Royal Horticultural Society's Bulletin



Miss RHODA POWER,
who to-day gives her last talk on 'Village Life in
Olden Days.' [London, 3.45.]

- 6.30 *S.B. from London (9.10 Local News)*
- 9.15 *S.B. from Liverpool*
- 9.45-11.0 *S.B. from London*

6KH HULL. 294 M.

- 3.30 Light Music
- 3.45 London Programme relayed from Daventry
- 4.0 Light Music
- 4.15 FIELD'S QUARTET, relayed from the New
Restaurant, King Edward Street
- 5.15 THE CHILDREN'S HOUR
- 6.0 London Programme relayed from Daventry
- 6.10 Mr. JESSE SKINNER, 'Country Topics—The
Production of Grade "A" Milk'
- 6.20 Royal Horticultural Society's Bulletin
- 6.30 *S.B. from London (9.10 Local News)*
- 9.15 *S.B. from Liverpool*
- 9.45-11.0 *S.B. from London*

2LS LEEDS-BRADFORD. 277.8 M. & 282.1 M.

- 11.30-12.30 FIELD'S CAFÉ ORCHESTRA, relayed
from Field's Café, Commercial Street, Leeds
- 3.45 London Programme relayed from Daventry
- 4.0 THE SCALA SYMPHONY ORCHESTRA, relayed
from the Scala Theatre, Leeds
- 5.0 AFTERNOON TOPICS: Miss D. NICHOLS,
'Readings from Edgar Allan Poe'
- 5.15 THE CHILDREN'S HOUR
- 6.0 Light Music
- 6.20 Royal Horticultural Society's Bulletin
- 6.30 *S.B. from London (9.10 Local News)*
- 9.15 *S.B. from Liverpool*
- 9.45-11.0 *S.B. from London*

6LV LIVERPOOL. 297 M.

- 3.0 CRANE'S MATINEE CONCERT
Relayed from CRANE HALL
ANDERSON TYRER (Pianoforte); CONSTANCE
IZARD (Violin); BRYN DAVIES (Baritone);
WALTER WRIGHT (Accompanist)
- 3.45 London Programme relayed from Daventry
- 4.0 MONTAGUE'S SYMPHONICS, relayed from
the Edinburgh Café Ballroom
- 5.0 AFTERNOON TOPICS: Mrs. LOVEDAY
CAMERON, 'Leisure'
- 5.15 THE CHILDREN'S HOUR
- 6.0 MONTAGUE'S SYMPHONICS, relayed from
the Edinburgh Café Ballroom
- 6.20 *S.B. from Manchester*
- 6.30 *S.B. from London (9.10 Local News)*
- 9.15 A LECTURE RECITAL by Dr. GEORGE
DYSON
(Director of Music, Winchester College)
on the

ANTIQUÉ INSTRUMENTS

In the RUSHWORTH AND DREAPER COLLEC-
TION, Liverpool
Relayed from the Rushworth Museum
Relayed to London and Daventry



Dr. GEORGE DYSON.

- 9.45-11.0 *S.B. from London*

5NG NOTTINGHAM. 275.2 M.

- 11.30-12.30 Programme relayed from Daventry
- 3.45 London Programme relayed from Daventry
- 4.0 THE MIKADO CAFÉ ORCHESTRA, conducted by
FREDERICK BOTTOMLEY

THE Rushworth and Dreaper collection contains what is claimed to be a unique assortment of antique musical instruments—clavichords, spinets, virginals, and wind instruments of curious shapes, often exquisitely made. It is about these that Dr. Dyson will talk to-night.

PROGRAMMES FOR WEDNESDAY (February 23)

- 4.45 Music and Afternoon Topics
 5.15 THE CHILDREN'S HOUR
 6.10 MABEL HODGKINSON (Pianoforte)
 6.20 S.B. from London (9.10 Local News)
 9.15 S.B. from Liverpool
 9.45-11.0 S.B. from London
-
- 5PY PLYMOUTH. 400 M.**
- 11.0-12.0 GEORGE EAST and his QUARTET, relayed from Popham's Restaurant
 3.30 Gramophone Recital
 3.45 London Programme relayed from Daventry
 4.0 Afternoon Topics
 4.15 TEA-TIME MUSIC: THE ROYAL HOTEL TRIO, directed by ALBERT FULLBROOK
 5.15 THE CHILDREN'S HOUR
 6.0 Mr. C. C. SYMONS will tell a Cornish Dialect Story
 6.20 S.B. from London (9.10 Local News)
 9.15 S.B. from Liverpool
 9.45-11.0 S.B. from London
-
- 6FL SHEFFIELD. 272.7 M.**
- 11.30-12.30 Gramophone Lecture Recital by MOSES BARITZ
 3.25 Prof. C. J. PATTEN, 'The Birds of the Sheffield Neighbourhood in Winter' (III)
 3.45 London Programme relayed from Daventry
 4.0 Miss KATE BALDWIN, 'Marmalade'
 4.15 London Programme relayed from Daventry
 5.15 THE CHILDREN'S HOUR: A Story for Scouts
 6.0 Musical Interlude
 6.20 Royal Horticultural Society's Bulletin
 6.30 S.B. from London (9.10 Local News)
 9.15 S.B. from Liverpool
 9.45-11.0 S.B. from London
-
- 6ST STOKE. 294 M.**
- 3.0 London Programme relayed from Daventry
 5.0 AFTERNOON TOPICS: The Rev. F. IVES CATER, 'Brass Rubbing as a Hobby'
 5.15 THE CHILDREN'S HOUR
 6.0 London Programme relayed from Daventry
 6.30 S.B. from London (9.10 Local News)
 9.15 S.B. from Liverpool
 9.45-11.0 S.B. from London
-
- 5SX SWANSEA. 294 M.**
- 3.0 London Programme relayed from Daventry
 4.0 THE CASTLE CINEMA ORCHESTRA and ORGAN MUSIC, relayed from the Castle Cinema
 5.0 Afternoon Topics
 5.15 THE CHILDREN'S HOUR
 6.0 LILIAN MORGAN, 'Once Upon a Time'
 6.20 S.B. from London (9.10 Local News)
 9.15 S.B. from Liverpool
 9.45-11.0 S.B. from London

Northern Programmes.

- 5NO NEWCASTLE. 312.5 M.**
 3.0—London Programme relayed from Daventry. 3.20—Mr. C. Bernard Stevenson: 'Art—Pictures in the Laing Art Gallery.' 3.45—London Programme relayed from Daventry. 4.0—Music from Foswick's Terrace Tea Rooms. 5.0—Rev. W. B. Hout: 'The Women of the Windows' (2). 5.15—Children's Hour. 6.0—Station Octet. 6.20—Royal Horticultural Society's Bulletin. 6.30—S.B. from London. 9.0—News. 9.15—S.B. from Liverpool. 9.45-11.0—S.B. from London.
- 5SC GLASGOW. 405.4 M.**
 3.0—Jeffries' Orchestra relayed from the Locarno Dance Salon. 3.20—Broadcast to Schools. 3.55—Handel Anniversary Programme. Wireless Quartet. 5.0—Agnes Miller: Lecture Recital—'George Frederick Handel.' 5.15—Children's Hour. 5.58—Weather Forecast for Farmers. 6.0—Prof. James Moffatt: 'Strolls in Literature.' 6.10—Musical Interlude. 6.20—Horticultural Bulletin—Mr. Dudley V. Howells. 6.30—S.B. from London. 8.45—The Gunn Boys (Tom and Bert). 9.0—News. 9.15—S.B. from Liverpool. 9.45-11.0—S.B. from London.
- 2BD ABERDEEN. 500 M.**
 3.45—London Programme relayed from Daventry. 4.0—Steadman's Symphony Orchestra, relayed from the Electric Theatre. 4.45—J. J. Moran (Humorist). 5.0—Afternoon Topics: Mrs. Gladys Pirie. 5.15—Children's Hour. 6.0—S.B. from Glasgow. 6.10—Music by the Station Octet. 6.30—S.B. from London. 9.50—News. 9.15—S.B. from Liverpool. 9.45-11.0—S.B. from London.
- 2BE BELFAST. 306.1 M.**
 3.0—Broadcast to Schools. London Programme relayed from Daventry. 3.45—London Programme relayed from Daventry. 4.0—Plaza Band, directed by R. M. Cole, relayed from the Plaza. 5.0—Afternoon Topics. 5.15—Children's Hour. 6.0—London Programme relayed from Daventry. 6.20—S.B. from London. 9.0—News. 9.15—S.B. from Liverpool. 9.45-11.0—S.B. from London.

Tuesday's Northern Programmes.

(Continued from Page 375.)

- 5NO NEWCASTLE. 312.5 M.**
 11.30—Norah Batey (Contralto). Martin Henderson (Concertina). 12.10-12.30—Gramophone Records. 3.0-3.45—London Programme relayed from Daventry. 4.0—The Station Octet. Elinora Hoggarth (Soprano). 5.0—London Programme relayed from Daventry. 5.15—Children's Hour. 6.0—A. E. Rogers (Baritone). 6.10—Fred Mayall (Violin). 6.20—A. E. Rogers. 6.25—Fred Mayall. 6.30—S.B. from London. 7.0—Prof. J. W. Bows: 'Curious Plants and Animals of South Africa' (1). 7.15—S.B. from London. 7.45—Music, Song and Humour. The Station Octet: Sophie Rowlands (Soprano); John Henry will Entertain; Tom Kinniburgh (Bass). 9.0—News. 9.15—S.B. from London. 9.25—Station Octet; Florence Holding (Soprano); Ernest Sharp (Violin). 10.30—Dance Music: Percy Bush's Eolian Band relayed from the Oxford Galleries. 11.15-12.0—S.B. from London.
- 5SC GLASGOW. 405.4 M.**
 11.30-12.30—Gramophone Records. 3.0—London Programme relayed from Daventry. 3.45—Dance Music relayed from the Plaza. 5.0—Afternoon Topics. 5.15—Children's Hour. 5.58—Weather Broadcast for Farmers. 6.0—Song Recital. Bella Redford (Mezzo-Soprano). 6.30—S.B. from London. 7.0—S.B. from Aberdeen. 7.15—S.B. from London. 7.45—Scottish Towns Series—(10) Renfrew. Address by Provost John McGregor. Renfrew Borough Band; Renfrew Male Voice Choir; Mary R. Gibson (Soprano); Archibald Jeffrey (Baritone); Alan Abrines (Tenor). 8.45—S.B. from London. 9.0—News. 9.15—Programme S.B. from Daventry. 10.10—Renfrew Programme (Continued). 10.45-12.0—S.B. from London.
- 2BD ABERDEEN. 500 M.**
 3.45—Afternoon Topics: Miss Marion Angus. 'Dramatic Moments in History' (4). 4.0—The Station Octet. Bella Smart (Soprano). 5.15—Children's Hour. 6.0—Music by the Station Octet. 6.30—S.B. from London. 7.0—Mr. Harry Townend. 'Flair.' 7.15—S.B. from London. 7.45—Variety. The Jap Hawaiian Quintet. 8.0—Doris Palmer (Comedienne). 8.15—Quintet. 8.24—Douglas S. Raitt (Entertainer). 8.45—S.B. from London. 9.0—News. 9.15—Programme S.B. from Daventry. 10.10—Dance Music relayed from the New Palace de Danse. 11.0-12.0—S.B. from London.
- 2BE BELFAST. 306.1 M.**
 11.0-1.0—Concert relayed from Daventry. 3.0-3.45—London Programme relayed from Daventry. 4.0—Light French Music (Gounod). The Station Orchestra. 4.25—Vocal Interlude. Florrie Carroll (Soprano). 4.37—Benjamin Godard. Orchestra. 5.0—Afternoon Topics: James Logan. 'School Humour' (2). 5.15—Children's Hour. 6.0—London Programme relayed from Daventry. 6.30—S.B. from London. 7.0—Mr. J. W. Coulter: 'The Modern Drama' (4). 7.15—S.B. from London. 7.45—In the Wake of H.M.S. 'Renown' (Due to arrive at Auckland, New Zealand, on February 22.) The programme will be introduced by the Hon. Sir James Parr, K.C.M.G., High Commissioner for New Zealand. Guide: Mr. H. P. B. Drew, of the Staff of the High Commissioner. Artists: Winifred Davis (Soprano), John Collinson (Tenor). The Station Players. The Station Orchestra. 9.0—News. 9.15—Programme S.B. from Daventry. 10.15-12.0—S.B. from London.

CHARACTERS

from
DICKENS
 No. 1



PICKWICK PAPERS

The Fat Boy assisted Mary to a little and himself to a great deal, and was just going to begin eating when he suddenly leant forward in his chair, and letting his hands fall on his knees, said very slowly: "I say, where are the Iron Jelloids?"

Iron Jelloids encourage the appetite. If you would have radiant health, an elastic step and well-braced nerves, you must have healthy blood. To improve and strengthen the blood, take Iron Jelloids. Iron Jelloids are palatable, reliable and easy to take. In cases of Anæmia and Weakness, Nerve Strain, Overwork, Convalescence, etc., in Men, Women and Children, Iron Jelloids will be found a most valuable treatment. A ten days treatment (costing 1/3) will convince you. Everyone should take Iron Jelloids now and again—They are the great Blood Enrichers.

THE HOSPITAL: "They deserve wide popularity."

Iron Jelloids

For Women IRON JELLOIDS No. 2
 For Children IRON JELLOIDS No. 1
 For Men IRON JELLOIDS No. 2A

Ten days Treatment 1/3. Five weeks treatment 3/-

The Iron Jelloid Co. Ltd., London, E.C.1.

PROGRAMMES FOR THURSDAY (February 24)

2LO LONDON. 361.4 M.

1.0-2.0 Time Signal, Big Ben. The Week's Concert of New Gramophone Records

2.25 Reading: 'Moby Dick,' by *Hermann Melville*

2.30 Mrs. H. A. L. FISHER, 'Before and After the War—A Hundred Years Ago'

WHEN Mrs. Fisher comes to discuss the conditions of rural England after the Napoleonic wars, she has an encouraging message for us in our quite similar plight to-day. A hundred years ago the English countryside was a gloomy scene of poverty, bankruptcy, starvation and every sort of distress, lighted up only by the lurid flames from burning ricks and the flaring torches of the Machine Breakers, for want had brought riot in its train. Conditions then were far worse than they are to-day, and yet the worst was over within twenty years of Waterloo.

3.0-3.45 EVENSONG relayed from WESTMINSTER ABBEY

4.0 TIME SIGNAL, GREENWICH

THE WALPOLE CINEMA ORCHESTRA, under the direction of FRANCIS R. DRAKE, relayed from the Walpole Cinema, Ealing

5.0 Topical Talk

5.15 THE CHILDREN'S HOUR: Part Songs by THE MANSFIELD ROAD L.C.C. BOYS' SCHOOL CHOIR. 'The Tale of Willie Waggle' (from 'The Merry-go-Round'), 'When the Zoo Sings,' by L.G.M. of the *Daily Mail*

6.0 Ministry of Agriculture Fortnightly Bulletin

6.15 Market Prices for Farmers

6.20 THE DAVENTRY QUARTET

6.30 TIME SIGNAL, GREENWICH; WEATHER FORECAST, FIRST GENERAL NEWS BULLETIN

6.45 THE DAVENTRY QUARTET

7.0 Mr. SETON GORDON, 'A Highland Deer Forest in Winter'

7.15 SCHUMANN'S 'MYRTLES'
Sung by DALE SMITH

TONIGHT we are to have the seventh to the thirteenth songs of the cycle.

VII. *Die Lotusblume (The Lotus Flower)*. This song, the words of which are Heine's, is very often sung by itself. The lotus flower is weary in the sunlight, and longs for the night. 'She loves the moonlight, and to it unveils her beauty. Thus blooming, she trembles with the fervour of love and love's pains.'

VIII. *Talismans (Talismans)*. In dignified declamation Goethe and Schumann declare the greatness of God, who rules over all, and enlightens and directs the souls of men.

IX. *Lied der Suleika (Suleika's Song)*. A simple love-poem by Goethe, telling that the sweetest of messages—that 'his heart and mine are one,' has been divined in a song.

X. *Die Hochländer Witwe (The Highland Widow)*. A setting of the well-known Burns poem about the poor woman who has 'come to the low country.' In her Highland home she was happy and well-to-do, but her husband fell at Culloden, and now she is poor and wretched.

XI. *Lied der Braut (Bride's Song)*. The next two poems set are by Rückert. In this the bride assures her mother that though she loves her husband, she will not love her less. Rather, remembering how much she owes to her mother, her love will increase for one who has been the means of her attaining happiness so great.

XII. This is a continuation of the idea of the previous song. The mother is anxious about the future. That, the girl says, none can tell; meanwhile, she begs that she may enjoy her happiness without a clouding thought.

XIII. *Hochländers Abschied (The Highlander's Farewell)*. This is another Burns song—the familiar 'My Heart's in the Highlands.' It is a song of brave and tender farewell to loved scenes.

7.25 Mr. R. R. MARETT, 'The Making of Man—(V) Government'

THE subject of government is one that we all think we know something about, but even those who have studied political science will find that the theory of government becomes much more complicated when it is approached from the anthropological point of view. Fortunately it becomes also more interesting, and listeners who want to have their minds stimulated and set on fresh tracks of thought will be well advised to hear Mr. Marett's talk this evening.

7.45 THE LONDON RADIO DANCE BAND, directed by SIDNEY FIRMAN

8.0 VARIETY ARTISTS' BENEVOLENT FUND
ROYAL COMMAND PERFORMANCE

Relayed from
THE VICTORIA PALACE

(See Special Programme on opposite page.)



Cholmondeley & Macnamara

Mr. DALE SMITH,

who sings Schumann's 'Poet's Love' and 'Myrtles' in the evening Classical Recitals this week. [London 7.15.]

SECOND GENERAL NEWS BULLETIN

(The time at which the Second General News Bulletin will be read will be announced over the microphone two or three days before this date.)

10.45 DANCE MUSIC

THE SAVOY ORPHEANS and THE SYLVIANs from the Savoy Hotel

11.30-12.0 RUNNING COMMENTARY

on the
CHELSEA ARTS BALL
Relayed from
THE ROYAL ALBERT HALL

5XX DAVENTRY. 1,600 M.

10.30 a.m. TIME SIGNAL, WEATHER FORECAST

11.0 TIME SIGNAL, BIG BEN

THE ETHEL VARICK TRIO: ETHEL VARICK (Violin); ROSE RUSH (Cello); TINA FOSTER (Pianoforte). ELSIE WYNN (Contralto); JOSEPH GREEN (Tenor); MIRIAM ANGLIN (Cello), MARGUERITE KING (Pianoforte)

1.0-2.0 S.B. from London

2.25-12.0 S.B. from London

(The time at which the Daventry Shipping Forecast will be announced will be given over the microphone two or three days before this date.)

5IT BIRMINGHAM. 326.1 M.

1.10-1.50 MIDDAY SERVICE relayed from St. MARTIN'S CHURCH. Speaker: Dr. NORWOOD, of the City Temple

3.45 THE STATION PIANOFORTE QUINTET: Lead r, FRANK CANTELL

4.45 AFTERNOON TOPICS: The Rev. REGINALD KIRBY, 'The Little Archer,' KATE HOULSTON (Soprano)

5.15 THE CHILDREN'S HOUR: Fairy Story by Phyllis Richardson, Songs by FLORENCE CLEETON (Soprano), 'Jungle Tab,' by Ernest R. Forbes

6.0 London Programme relayed from Daventry

6.30 S.B. from London

7.0 Mr. JOHN HUMPHREYS, 'About Snakes'

7.15-12.0 S.B. from London

6BM BOURNEMOUTH. 491.8 M.

11.15-12.15 MIDDAY MUSIC from BEALE'S RESTAURANT, Old Christchurch Road. Directed by GILBERT STACEY

2.30-3.45 London Programme relayed from Daventry

4.0 Miss L. F. RAMSEY, 'The Village Child'

4.15 TEA-TIME MUSIC from BEALE'S RESTAURANT, Old Christchurch Road. Directed by GILBERT STACEY

5.15 THE CHILDREN'S HOUR

6.0 London Programme relayed from Daventry

6.30 S.B. from London

7.0 Mr. RISON BENNETT, 'An Unlucky Statesman: Henry St. John—First Viscount Bolingbroke, "Queen Anne's Dead" (Old Proverb)'

7.15-12.0 S.B. from London

5WA CARDIFF. 353 M.

12.30-1.30 LUNCH-TIME MUSIC from the Carlton Restaurant

3.0 THE STATION ORCHESTRA

Overture to 'Tannhäuser' Wagner
First 'Pomp and Circumstance' March ... Elgar

3.15 BROADCAST TO SCHOOLS: 'The Orchestra and Its Instruments,' as revealed by Sir WALFORD DAVIES and WARWICK BRAITHWAITE, with the Station Orchestra

3.40 ORCHESTRA

Second 'Carmen' Suite Bizet
W. L. COBLEY (Tenor)

The Palm Trees Morgan
A Little Coon's Prayer Barbara Melville

Mary of Argyle S. Nelson

ORCHESTRA

'The Prague' Symphony Mozart
W. L. COBLEY

Lola of the Forest Kennedy Russell
Fly Away, Nightingale Rubinstein

Rosebud Frederick Drummond

ORCHESTRA

Russian Ballet Luigini

4.45 Mrs. D. PORTWAY DOBSON, 'Dress Through the Ages—Roman Times'

5.0 ORCHESTRA

Intermezzo, 'Cavalleria Rusticana' ... Mascagni
Overture, 'Joan and Sam' Ansell

(Continued on page 382.)

THE ROYAL VARIETY PERFORMANCE

In Aid of the Variety Artists' Benevolent Fund.

Thursday, Feb. 24—

8.0—10.45.



MONA GREY,
the vari-voiced. She can impersonate a complete musical soiree, from the violin recital to the tenor's song, not forgetting the infant prodigy, or the gramophone that fills in the gaps.



Mr. FLOTSAM and Mr. JETSAM,
are here seen at the microphone, giving one of those humorous news-bulletins that have delighted radio audiences on many occasions.



LILY MORRIS,
Marie Lloyd's successor, now the dismal Cockney charwoman, and now the dashing 'Principal Boy.' Have you ever heard her sing 'Cause he's only a working man'? Anyway, you will to-night.



WEE GEORGIE WOOD,
the boy impersonator, 'Black Hand George' and 'Wee McGregor,' who is as popular in America and Australia as he is on the London and provincial halls.

PROGRAMME
(Relayed from the Victoria Palace)

Mr. FLOTSAM and Mr. JETSAM
'AUNTIE'
JACK EDGE
MONA GREY
THE HUXTER BROTHERS
NORMAN LONG
LILY MORRIS
DEBROY SOMERS
ALBERT WHELAN
WEE GEORGIE WOOD
and
THE VICTORIA GIRLS

Some of the turns in this programme rely largely on visual effects for their success. In order to help our listeners to understand what is going on at such moments, TOMMY HANDLEY, the well-known broadcasting comedian, will give a brief running description of such turns.



DEBROY SOMERS,
who won the gratitude of so many listeners when he was leader of the Savoy Orpheans, is now the inspiration of his own All-British Band.



NORMAN LONG—
'a song, a smile and a piano.' You will hear the song and the piano, and here is the smile. Centre: the Victoria Girls—the smartest eight in London—will be on their native heath to-night.



ALBERT WHELAN,
whose famous whistling entrance has gladdened audiences all over the world. You wouldn't think he began as a gold-digger, to see him now—there is not a more immaculate dress-suit on the stage.

PROGRAMMES FOR THURSDAY (February 24)

(Continued from page 380.)

- 5.15 THE CHILDREN'S HOUR
- 6.0 London Programme relayed from Daventry
- 6.30 S.B. from London
- 7.0 Miss ESYLT NEWBERRY: 'Eastern Cameos—Ceylon Pearl Fishes'
- 7.15-12.0 S.B. from London

2ZY MANCHESTER. 384.6 M.

- 11.30-12.30 MUSIC by THE STATION QUARTET
Selection from 'The Lullar Princess' Fall
Three Dances ('Nell Gwyn') German
Ballet, 'The Rake' Roger Quilter
Cossack's Wedding Feast Krein
Selection from 'La Tosca' Puccini



Woodcut by Grace Golden. By courtesy of the Aeolian Co., Ltd.

ROBERT SCHUMANN'S FIRST LESSONS.

His teacher was a musical 'general practitioner' of the neighbourhood, named Kuntzsch, a schoolmaster-bandmaster-organist of no very high artistic attainments. One of his methods (and a practical one) is said to have been to seat his pupils at the organ, letting them play chorales, or hymn-tunes, as if to a congregation, and improvising between the verses the interludes customary in German churches. Schumann's songs are being sung in the Evening Classical Recitals this week. [London, 7.15.]

- 4.30 AFTERNOON TOPICS: Mr. F. SLADEN SMITH, 'The Adventurous Playgoer'
- 4.45 TEA-TIME MUSIC: J. MEADOWS (Auto-Piano Recital)
- 5.0 CONSTANCE SYLVESTER (Blind Mezzo-Soprano)
Who Is Sylvia? Schubert
To Music Schubert
Serenade Schubert
The River of Years T. Marzials
- 5.15 THE CHILDREN'S HOUR: 'Pets and Their Care—(2) Cats.' Sérénade and Souvenir (*Drdla*) played by DON HYDEN. Chansonette by Cyril Scott, played by ERIC FOGG
- 6.0 London Programme relayed from Daventry
- 6.30 S.B. from London
- 7.0 Mr. H. BLACKBURN, 'The Deep-Sea Fisheries'
- 7.15-12.0 S.B. from London

6KH HULL. 294 M.

- 11.30-12.30 Gramophone Records
- 4.0 AFTERNOON TOPICS: Mr. C. H. PHILLIPS, 'That Classical Music'
- 4.15 FIELD'S QUARTET, relayed from the New Restaurant, King Edward Street
- 5.15 THE CHILDREN'S HOUR
- 6.0 London Programme relayed from Daventry
- 6.30 S.B. from London
- 7.0 Mr. HIRAM P. BAILEY, 'South American Experiences'
- 7.15-12.0 S.B. from London

2LS LEEDS-BRADFORD. 277.8 M. & 252.1 M.

- 11.30-12.30 FIELD'S CAFÉ ORCHESTRA, relayed from Field's Café, Commercial Street, Leeds
- 4.0 FIELD'S CAFÉ ORCHESTRA
- 5.0 Afternoon Topics
- 5.15 THE CHILDREN'S HOUR
- 6.0 London Programme relayed from Daventry
- 6.30 S.B. from London
- 6.45 FOR SCOUTS: Band of the 18th N.E. Leeds (Halton Templars)
- 7.30-12.0 S.B. from London

6LV LIVERPOOL. 297 M.

- 4.0 HAROLD GEE and his ORCHESTRA from the Trocadero Cinema
- 5.0 Readings by Mr. H. C. PEARSON
- 5.15 THE CHILDREN'S HOUR
- 6.0 London Programme relayed from Daventry
- 6.30 S.B. from London
- 7.0 Prof. A. Y. CAMPBELL, 'The Delights of Rhyme'
- 7.15-12.0 S.B. from London

5NG NOTTINGHAM. 275.2 M.

- 11.30-12.30 Concert relayed from Daventry
- 2.40 BROADCAST TO SCHOOLS: Prof. H. H. SWINNERTON, 'The Geography of Nottingham and Its Little Sisters' (VI)
- 3.0-3.45 London Programme relayed from Daventry
- 4.0 ALICE DAY (Violin)
FLORENCE PARR (Soprano)
IDA SARGENT (Songs at the Piano)
- 5.15 THE CHILDREN'S HOUR
- 6.0 London Programme relayed from Daventry
- 6.30 S.B. from London
- 7.0 Prof. R. PEERS, 'Living and Learning—(II) The Meaning and Importance of Learning'
- 7.15-12.0 S.B. from London

5PY PLYMOUTH. 400 M.

- 11.0-12.0 GEORGE EAST and his QUARTET, relayed from Popham's Restaurant
- 3.30 ORCHESTRA, relayed from POPHAM'S RESTAURANT
- 4.0 AFTERNOON TOPICS: Mr. P. FRANKLIN CHAMBERS, 'The Romance of the Schumanns'
- 4.15 TEA-TIME MUSIC: THE ROYAL HOTEL TRIO, directed by ALBERT FULLERBROOK
- 5.15 THE CHILDREN'S HOUR
- 6.0 London Programme relayed from Daventry
- 6.50 S.B. from London
- 7.0 Miss MARGARET KENNEDY: 'Milton'
- 7.15-12.0 S.B. from London



Woodcut by Grace Golden. By courtesy of the Aeolian Co., Ltd.

CLARA SCHUMANN (1819-1896).

She was the daughter and pupil of the famous piano teacher, Frederick Wieck, of whom Schumann was also a pupil, and was, even in her girlhood, one of the most admired pianists of Europe. Wieck forbade her marriage with Schumann, who had to fight a legal action in order to force consent to the union. In the year of happiness achieved (1840) Schumann burst into song. Most of his songs date from this period, including those that are being sung this week in the Classical Recitals. [London, 7.15.]

6FL SHEFFIELD. 272.7 M.

- 4.0 Afternoon Topics
- 4.15 ORGAN, relayed from the ALBERT HALL
- 5.15 THE CHILDREN'S HOUR: Another Competition
- 6.0 London Programme relayed from Daventry
- 6.30 S.B. from London
- 7.0 Mr. S. C. SMITH, District Manager of Post Office Telephones, 'How to Use the New Automatic Telephones in Sheffield'
- 7.15-12.0 S.B. from London

The Pianos in use in the various stations of the British Broadcasting Corporation are by CHAPPELL and WEBER.

Programmes for Thursday.

65T **STOKE.** 294 M.

- 12.0-1.0 THE STATION QUARTET
- 3.0 London Programme relayed from Daventry
- 5.0 AFTERNOON TOPICS: JEAN WHITFORD. 'Lucky People'
- 5.15 THE CHILDREN'S HOUR
- 6.0 London Programme relayed from Daventry
- 6.20 Light Music
- 6.30 S.B. from London
- 7.0 Mr. ROGER WAIN: 'Industrial Series—(VIII) The North Staffordshire Coalfields'
- 7.15-12.0 S.B. from London

5SX **SWANSEA.** 294 M.

- 11.30-12.30 Gramophone Records
- 2.30-3.45 London Programme relayed from Daventry
- 4.0 THE STATION TRIO
CHARLES WARD (Blind T. boy)
MORWEN WILLIAMS (Soprano)
- 5.15 THE CHILDREN'S HOUR
- 6.0 London Programme relayed from Daventry
- 6.30 S.B. from London
- 7.0 Mr. J. W. THORPE: 'The Human Side of a Police Court—(III)'
- 7.15-12.0 S.B. from London

Northern Programmes.

5NO **NEWCASTLE.** 312.5 M.

- 2.30-3.45:—London Programme relayed from Daventry.
- 4.0:—Station Octet. May Osborne (Mezzo-Soprano). 5.0:—London Programme relayed from Daventry. 5.15:—Children's Hour. 6.0:—For Farmers: Prof. D. A. Gilchrist. 'Seasonable Notes.' 6.15:—London Programme relayed from Daventry. 6.30:—S.B. from London. 7.0:—Mr. T. Russell Goddard. 'The Trials of a Museum Curator.' 7.15-12.0:—S.B. from London.

5SC **GLASGOW.** 405.4 M.

- 3.0:—Dance Music relayed from the Piccadilly Dance Club.
- 3.20:—Broadcast to Schools: Mr. J. P. McHutchinson. 'Science in Everyday Life—How Heat Travels.' 3.32:—Mr. John Talman. 'English Literature.' Musical Item to Schools: Selection. 'The Tales of Hoffmann' (Offenbach). 3.55:—Wireless Quartet. Gilbert A. Highet (Songs with Ukulele Accompaniment). 5.0:—Afternoon Topics: Lady Margaret Sackville. 'Peppy's Diary.' 5.15:—Children's Hour. 5.58:—Weather Forecast for Farmers. 6.0:—S.B. from Aberdeen. 6.15:—Market Prices for Farmers. S.B. from Edinburgh. 6.20:—Light Music. 6.30:—S.B. from London. 7.0:—S.B. from Dundee. 7.15-12.0:—S.B. from London.

2BD **ABERDEEN.** 500 M.

- 3.0:—Concert to Schools relayed from Cowdray Hall. 4.0:—Afternoon Topics. 4.15:—Constance J. Soutar (Soprano). 4.25:—Station Octet. 5.15:—Children's Hour. 6.0:—Mr. W. M. Findlay, U.D.A.: 'Rotation Grass.' 6.15:—S.B. from Edinburgh. 6.20:—Light Music. 6.30:—S.B. from London. 7.0:—S.B. from Dundee. 7.15-12.0:—S.B. from London.

2BE **BELFAST.** 306.1 M.

- 3.0:—Broadcast to Schools: Prof. Alan MacKinnon. 'How to Enjoy Reading.' 4.0:—Carlton Orchestra, directed by Harold Spencer, relayed from the Carlton Cafe. 5.0:—Afternoon Topics: Miss Florence Irwin. 'Cleaning Mixtures for Wood and Metal.' 5.15:—Children's Hour. 6.0:—London Programme relayed from Daventry. 6.30:—S.B. from London. 7.0:—Mr. Harry Douglas. 'Dry Fly Fishing' (II). 7.15-12.0:—S.B. from London.



A 10" double-sided Gramophone Record

CHOOSE FROM THIS LIST:—

LIST of "IMPERIAL" RECORDS

Gift No. 336.
When ordering, please state: GIFT AND SERIAL NUMBER, i.e.: Gift No. 336, Serial No. 1653 (or number selected) and so on.

Serial Number of Music.	Name and Particulars.	Serial Number of Music.	Name and Particulars.
DANCES.			
1653	"DYE BYE, BLACK-BIRD" (Blue Bonnet)	1661	"DYE BYE, BLACK-BIRD" (Who)
1612	"THAT CERTAIN PARTY" (Cross My Heart, Mother, I Love You)	1645	"WHEN THE RED, RED ROBIN COMES BOBBIN' ALONG" (What Good is 'Good Morning'?)
1651	"WHEN THE RED, RED ROBIN COMES BOBBIN' ALONG" (Me Too, Ho! Ho! Ha! Ha!)	1681	"WHILE THE SAHARA SLEEPS" (Way Down Home)
1674	"WHILE THE SAHARA SLEEPS" (Hi-Diddle-Dee-Dee)	1622	"GOOD NIGHT, I'LL SEE YOU IN THE MORNING" (Don't Care What You Used To Be, I Know What You Are To-day)
1624	"GOOD NIGHT, I'LL SEE YOU IN THE MORNING" (Say It Again)	1649	"AM I WASTING MY TIME ON YOU?" (I Wish I Had My Old Girl Back Again)
1656	"AM I WASTING MY TIME ON YOU?" (My Casey's Due at Two-to-Two To-day)	1603	"JUST A COTTAGE SMALL" (At Peace with the World)
1659	"OH, CHARLIE, TAKE IT AWAY" (My Carmelita)	1567	"PAL OF MY CRADLE DAYS" (Yorkshire)
1637	"SUNNY" (FROM "SUNNY") (Who)	1657	"ANY ICE TODAY, LADY?" (Me Too, Ho! Ho! Ha! Ha!)
1590	"BARCELONA" (On the Midnight Special)	1650	"SO IS YOUR OLD LADY" (The Pump Song)
1554	"PAL OF MY CRADLE DAYS" (The Prisoner's Song)	1595	"KING COTTON" (Pomp and Circumstance)
HAWAIIAN GUITAR RECORDS.			
1660	"DREAMY SWANEE HULLABY" (Sun-Kissed Hawaii)	1603	"BLAZE AWAY" (The Bullfighters)
1545	"BOWSY WATERS" (In Galandrina)	1131	"BOONIE HEATHER JIG" (Baby Rose)
LAUGHING RECORD.			
1189	"THE LAUGHING RECORD" (The Mocking Bird)		

The titles shown in brackets appear on the reverse side of the Records.
List of over 200 popular "Imperial" Records available can be obtained on application.

Just think of it! Gramophone Records free—all the popular Fox-trots, One-steps, Songs, in fact, all the best and latest music!

Hearing is believing, so get one of these records. You will find the tone as round and mellow as in "Black Cat" Cigarettes which are more popular than ever.

Black Cat

VIRGINIA CIGARETTES

10 FOR 6^d

FILL IN THIS COUPON NOW

To The BLACK CAT CIGARETTE CO., (Dept. 105), Gifts Dept., 12, Bath Street, City Road, LONDON, E.C.1.

Please send me list of records, Free Booklet and Five Free Coupons.

Name.....

Address.....

ONLY ONE OF THESE SIGNED COUPONS WILL BE ACCEPTED.

NOTE:—GIFTS DEPT. NEW ADDRESS. 12, Bath St., City Road, London, E.C.1.

PROGRAMMES FOR FRIDAY (February 25)

2LO LONDON. 361.4 M.

(1.0 Time Signal, Big Ben)

1.0-2.0 LUNCH-TIME MUSIC from the Hotel Metropole

3.15 Reading: 'Emma,' by Jane Austen

3.20 M. STÉPHAN, 'Elementary French'

3.45 CONCERTS FOR SCHOOL CHILDREN
Arranged by the PEOPLE'S CONCERT SOCIETY
in co-operation with the B.B.C.
Sixth Concert of Fifth Series
Relayed from the Northern Polytechnic
THE KENDALL STRING QUARTET
and
KATHLEEN COOPER (Solo Pianoforte)
Part I
Devoted to Music by Mozart (1756-1791)



FOR LONDON LISTENERS.

Miss Estelle Brody and Mr. Cyril Lidington, who will entertain London listeners from 10.35-11.0 to-night.

Two Movements from Quartet for Strings in F
Minuet—Allegro
Pianoforte Solo, Rondo in D
Two Movements from Quartet for Pianoforte and
Strings in G Minor
Allegro—Finale (Rondo)

The second part of the Programme will include miscellaneous items, the titles of which will be given out by the Announcer.

4.45 EDITHA BRAHAM (Violin)

Sonata in G Minor *Tartini*
Allegro from Symphonie Espagnole *Lalo*
Waltz in A *Brahms-Hochstein*
Hungarian Dance *Brahms-Joachim*

5.15 THE CHILDREN'S HOUR: Songs by FLORENCE
OLDHAM; 'Snow White and Rose Red' (A
Short Playlet by Harcourt Williams); 'The
Invalid' (H. Mortimer Batten)

6.0 FRANK WESTFIELD'S ORCHESTRA, from the
Prince of Wales Playhouse, Lewisham

6.30 TIME SIGNAL, GREENWICH; WEATHER FORE-
CAST, FIRST GENERAL NEWS BULLETIN

6.45 FRANK WESTFIELD'S ORCHESTRA (Continued)

7.0 Mr. G. A. ATKINSON: 'Seen on the Screen'

FILM fans' look forward eagerly to Mr.
Atkinson's fortnightly review of note-
worthy new pictures; he always has something
fresh and stimulating to say.

7.15 SCHUMANN'S 'MYRTLES'

Sung by DALE SMITH

THE fourteenth to the nineteenth songs of
the cycle are now to be sung.

XIV. *Hochländisches Wiegenlied* (Highland
Cradle Song). A lullaby (the words by Burns)
to a baby of a roving clan, who is playfully told
of his future career—as a cattle stealer.

XV. *Mein Herz ist schwer* (My heart is heavy).
A setting of a poem of Byron. The speaker calls
for the music of the harp, to bring forth a tear
that shall save the heart from bursting with
grief.

XVI. *Räthsel* (Enigma). Everyone knows
Byron's clever conundrum beginning

'Twas whispered in heaven, 'twas muttered in
hell,

And echo caught faintly the sound as it fell.

Schumann has set the enigma in a declamatory
style. In the last line a clue is given—'Oh,
breathe on it softly, it is but a ('tis what?) it is
but a breath.'

(The solution to the enigma is the letter H.)

XVII. *Leis' rudern hier* (Row gently here). A
setting of a gondola song by Tom Moore. The
lover, preparing to climb his lady's balcony,
while the gondolier keeps watch below, piously
reflects what angels we should be if we took half
the pains for heaven that we take for love!

XVIII. *Wenn durch die Piazzetta* (When
through the Piazzetta). Another love song by
Moore—a brief page about a rendezvous.

XIX. *Der Hauptmann's Weib* (The Captain's
Lady). This is a setting of the well-known
Burns poem, beginning

O mount and go,

Mount and make you ready:

O mount and go

And be the Captain's Lady.

Her lot shall be to see her love in battle, and
then, 'when the vanquished foe seeks for peace
and quiet,' to enjoy the sweets of love.

7.25 Prof. C. H. REILLY, 'Some Modern Buildings—
(3) The Streets of To-day.' S.B. from Liverpool

AFTER discussing the modern office-block,
church and small house, Professor Reilly
proceeds to an architectural problem still further
from being solved—that of the street considered
as an architectural whole. Since the early
nineteenth century London, for instance, has
allowed its streets to grow up haphazard, with
the results that we see in such heterogeneous
strings of ill-assorted buildings as Oxford Street
and the Strand. Within the last year or two
we have seen the final disappearance of the old
Regent Street, one of the great triumphs of street-
design, and its replacement by a modern attempt
which, in the opinion of many critics, is a lament-
able failure. Professor Reilly is known to hold
strong views on this subject, and what he has to
say on the new street—a picture of which appears
on the next page—and on the whole question of
street-design will be of particular interest to
listeners.

7.45 ARCHIBALD FORBES (Raconteur)
SAXOPHONE OCTET

8.15 'ORPHEUS'

An Opera by Gluck

Cast:

Orpheus PHYLLIS ARCHIBALD
Eurydice ALICE MOXON
Cupid KATHLYN HILLIARD

THE WIRELESS SYMPHONY ORCHESTRA

THE WIRELESS CHORUS

Conducted by PERCY PITT

Chorus Master—STANFORD ROBINSON

ACTS I. and II.

GLUCK'S *Orpheus* is probably the earliest
written Opera that still keeps the stage—the
ordinary, more or less commercial stage, that
is, for there is an earlier work (and a British one)
that is still frequently heard in private and semi-
public performances—Purcell's *Dido and Aeneas*.
We in this country do not often hear the Gluck
masterpiece (though there have been some very
notable performances of it within recent times)
but it is in the regular repertory of the chief
Opera Houses of Europe, as well it may be, for
it is full of lovely tunes (the lament of Orpheus,
Che farò? 'What shall I do?' is, in itself, a
melodic treasure), and has some very moving
dramatic moments.

The plot of the Opera is based on one of the
legends of the old Greek world. Gluck follows
the legend in its usual form, but gives it a happy
ending.

The work is, in this performance, divided into
four Acts.

At the opening of the Opera, Orpheus and his
friends are lamenting at the tomb of his bride,

Eurydice, who has died from a serpent's sting.
Amor, the god of Love, brings word to Orpheus
that he may descend to the underworld, and, by
his wonderful singing and harping, win her back
to earth—if only he can refrain from looking on
her until the return has been accomplished.

In Acts Two and Three Orpheus descends, and
after fierce trial prevails upon the powers that
reign below to give Eurydice back to him.

Act Four. In their long journey back to earth
he is over-tempted and cannot resist looking upon
her, and so loses her, but she is finally restored
to him by the gods as a reward for his suffering.

Those who care to read something about Gluck's
life and his great work for Opera may like to read
Berlioz' *Gluck and His Operas* (W. Reeves, 5s.),
or Newman's *Gluck and the Opera*. This book is
out of print, but may be seen in many Public
Libraries, where also may be consulted Hadow's
The Viennese Period (Vol. V. of the *Oxford History
of Music*, published by the Oxford University



IN 'ORPHEUS' TO-NIGHT.

On the left is Miss Alice Moxon, who will take
the part of Eurydice, and on the right Miss
Kathlyn Hilliard, to-night's Cupid.

Press at 25s.), and the article on Gluck in Grove's
Dictionary of *Music and Musicians*. There is a
chapter on Gluck in Romain Rolland's *Some
Musicians of Former Days* (Kegan Paul, 4s. 6d.)

(A libretto of this Opera is published by, and is
obtainable from, the B.B.C. For full details see
the announcement on page 392 of this issue.)

9.0 TIME SIGNAL, GREENWICH; WEATHER FORE-
CAST, SECOND GENERAL NEWS BULLETIN; Local
Announcements

9.15 'ORPHEUS'
ACTS III and IV

10.20 Topical Talk

10.35-11.0 ESTELLE BRODY (Syncopation)

CYRIL LIDINGTON

In Items from his Repertoire

5XX DAVENTRY. 1,600 M.

10.30 a.m. TIME SIGNAL, WEATHER FORECAST

11.0 TIME SIGNAL, BIG BEN

THE DAVENTRY QUARTET and JOHANNA C.
GESINA VOLLES (Soprano); JOHN THORNE
(Baritone); GERTRUDE HUNTLY (Pianoforte)

12.30 ORGAN RECITAL

by

LEONARD H. WARNER

Relayed from St. Botolph's, Bishopsgate
Chorale, No. 2, in B Minor *Cesar Franck*
Fantasie-Prelude *Chas. Mucpherson*
Triumphal March *Hollins*

1.0-2.0 S.B. from London

3.15 S.B. from London

9.10 Shipping Forecast

9.15 S.B. from London

11.0-12.0 DANCE MUSIC

KETTNER'S FIVE, under the direction of GEOFFREY
GELDER, from Kettner's Restaurant

PROGRAMMES FOR FRIDAY (February 25)

5IT BIRMINGHAM. 326.1 M.

- 3.20 London Programme relayed from Daventry
- 4.45 AFTERNOON TOPICS: MARY DORMER HARRIS, 'Warwickshire Villages and Churches.' MARJORIE DAMS (Contralto)
- 5.15 THE CHILDREN'S HOUR
- 6.0 HAROLD TURLEY'S ORCHESTRA, relayed from Prince's Café
- 6.30 S.B. from London
- 7.25 S.B. from Liverpool

VARIETY

- 7.45 MASON and ARMES (Entertainers with a Piano)
- 8.0 DORIS PALMER (Comedienne)
- 8.15-11.0 S.B. from London (9.10 Local News)

6BM BOURNEMOUTH. 491.8 M.

- 3.20 London Programme relayed from Daventry
- 4.45 E. GEE NASH: 'Translations from Foreign Literature—(VII) A Story from the Swedish'
- 5.0 Musical Interlude
- 5.15 THE CHILDREN'S HOUR
- 6.0 ORCHESTRAL MUSIC, relayed from the Grand Super Cinema, Westbourne. Directed by ISADORE GODOWSKY
- 6.20 HIS WORSHIP THE MAYOR OF BOURNEMOUTH, Councillor HARRY J. THWAITES: 'Citizen Sunday'
- 6.30 S.B. from London
- 7.25 S.B. from Liverpool

7.45 GUY WEATHERBY'S DILEMMA A Comedy by HILDA P. K. CHAMBERLAIN

Cast:

- Weatherby JOHN CHARLTON
- McGregor J. HUBERT LESLIE
- A Boy FRED PEISLEY
- A Client PERCY RHODES
- A Man DUNCAN MACRAE
- A Girl PHYLLIS PANTING

In the setting of a modern business office, with its usual appurtenances, including a somewhat conspicuous clock, a mild complication is played to an amusing finish.

The diplomacy which involves Guy Weatherby, Jim McGregor, a girl, and a man, up to the moment of humorous climax, will provide listeners with a good thirty-minute chuckle.

- 8.15-11.0 S.B. from London (9.10 Local News)

5WA CARDIFF. 353 M.

- 3.20 London Programme relayed from Daventry
- 4.45 Mr. GEOFFREY WEST: 'Parody—Examples of the Highest Type'
- 5.0 TEA-TIME MUSIC from the Carlton Restaurant
- 5.15 THE CHILDREN'S HOUR
- 6.0 ORGAN RECITAL by ARTHUR E. SIMS
Relayed from the Central Hall, Newport
Prelude and Fugue in D Major, F. Dela Tombe
Selection from 'Hiawatha's Wedding Feast'
Coleridge-Taylor
Meditation D'Evry
Toccata

- 6.30 S.B. from London

- 7.25 S.B. from Liverpool

- 7.45-11.0 S.B. from London (9.10 Local News)

2ZY MANCHESTER. 384.6 M.

- 1.15-2.0 PIANOFORTE TRIO, from the Piccadilly Picture Theatre

- 3.25 BROADCAST TO SCHOOLS: Mr. W. E. BULLOCKS, 'Travel Pictures of the British Empire: India—(VI) The Village Life of Eastern Bengal'

- 3.45 DOROTHY KENYON (Pianoforte)
The Naiads ('Pictures from Greece') .. Farjeon
Nocturne in F Sharp Chopin
First Ballade in G Minor

- 4.0 Music by THE STATION QUARTET
Selection from 'The Mousmé'
Monckton and Talbot
Three Irish Scenes (First Performance)
Oscar Maylor
Waltz, 'Venus' Gung'l
Overture, 'The Siege of La Rochelle' .. Balfe

- 5.0 AFTERNOON TOPICS: Mr. FRANK A. LOWE, F.Z.S., 'Bird Calls, with Vocal Illustrations'

- 5.15 THE CHILDREN'S HOUR: The Story of Opera: 'Tom Jones,' Illustrated by the SUNSHINE TRIO, BETTY WHEATLEY and HARRY HOPEWELL

- 6.0 THE MAJESTIC 'CELEBRITY' ORCHESTRA, from the Hotel Majestic, St. Annes-on-the-Sea. Musical Director, GERALD W. BRIGHT

- 6.30 S.B. from London

- 6.45 THE MAJESTIC 'CELEBRITY' ORCHESTRA (Continued)

- 7.0 S.B. from London

- 7.25 S.B. from Liverpool

- 7.45 BEETHOVEN'S 'KREUTZER' SONATA
WINIFRED SMALL (Violin)
MAURICE COLE (Pianoforte)

- 8.15-11.0 S.B. from London (9.10 Local News)

6KH HULL. 294 M.

- 11.30-12.30 Gramophone Records

- 3.30 BROADCAST TO SCHOOLS: Mr. K. GRAHAM THOMSON, 'How Our History Grew—(VI) The Influence of the Sea'

- 4.0 Afternoon Topics

- 4.15 FIELD'S QUARTET, relayed from the New Restaurant, King Edward Street

- 5.15 THE CHILDREN'S HOUR

- 6.0 London Programme relayed from Daventry

- 6.15 Mr. J. G. STEPHENS: Weekly Football Talk

- 6.30 S.B. from London

- 7.25 S.B. from Liverpool

- 7.45-11.0 S.B. from London (9.10 Local News)

2LS LEEDS-BRADFORD. 277.8 M. & 252.1 M.

- 11.30-12.30 Field's Café Orchestra, relayed from Field's Café, Commercial Street, Leeds

- 3.20 BROADCAST TO ELEMENTARY SCHOOLS: Mr. S. J. CURTIS, 'The Story of Our Language—(IV) The Story of Some Interesting Words'

(Continued on page 386.)

PRUDENTIAL BONUS INCREASED

The Directors of The Prudential Assurance Company Ltd. have declared, in respect of the year 1926, an increased Reversionary Bonus payable on all participating Policies in the Ordinary (Life) Branch of the Company. The new rate of Bonus is

£2-4-0 PER CENT.

This represents an addition of £22 to the amount of every £1,000 (with profit) Prudential life policy.

To young men who assure their lives before age 28, this represents more than the amount of the annual premium for a whole life with-profit policy. Or, put in another way, the representatives of the man who assures in the Prudential before age 28 will, assuming this rate of bonus be maintained, receive £1,000 in addition to the amount paid by way of premium.

THE PRUDENTIAL ASSURANCE COMPANY LIMITED, HOLBORN BARS, E.C.1.

Representatives Everywhere. Mention this Paper. P.P.107.

DOUBLE your earning power

You're ambitious. You want to get on—to earn more money. Then start at once to qualify for the better position which nothing but a vocational training can ensure for you.

No matter what line or class of business you follow or desire to engage in, your advancement will depend largely upon the thoroughness of your training; but by taking an I.C.S. Course of Instruction you will go far towards making sure of success. Tens of thousands of British men and women are better off, happier, and much more confident of the future through studying an I.C.S. Course in their spare time.

If you are in any uncertainty about your future and feel that a little expert advice would be helpful to you, write to us to-day. Your letter will be answered by a specialist. That will cost you nothing and place you under no obligation.

The I.C.S. have some 360 Standard Courses, of which the FOLLOWING are the more IMPORTANT groups:

- | | |
|------------------------|--|
| Accountancy & Bk.-kng. | Railway Equip. & Runn'g |
| Advertising | Salesmanship |
| Architecture | Scientific Management |
| Building | Shorthand Typewriting |
| Commercial Art | Showcard Writing |
| Draughtsmanship | Textiles |
| French and Spanish | Window Dressing |
| General Education | Wireless Telegraphy |
| Plumbing | Woodworking |
| | Engineering (all branches, state which). |
| | Professional Examinations (state which). |

There is a Special Booklet for each group, which will be sent free on request. Tell us the one you would like to see.

International Correspondence Schools, Ltd., 81, International Buildings, Kingsway, London, W.C.2

PROGRAMMES FOR FRIDAY (February 25)

(Continued from page 385.)

- 4.0 BROADCAST TO SECONDARY SCHOOLS: Mr. S. C. KAINES SMITH, 'The History of History—(IV) The Historian Himself'
- 4.30 THE SCALA STRING QUINTET, relayed from the Scala Theatre, Leeds
- 5.0 Afternoon Topics
- 5.15 THE CHILDREN'S HOUR
- 6.0 Light Music
- 6.30 S.B. from London
- 7.25 S.B. from Liverpool
- 7.45-11.0 S.B. from London (9.10 Local News)

6LV LIVERPOOL. 297 M.

- 3.15-3.45 BROADCAST TO SCHOOLS: Prof. G. S. VETTOR, 'Britain in Ancient Times—(1) The First Tool-makers'
- 4.0 WILLIAM H. RATCLIFFE (Baritone)
- 4.15 THE STATION PIANOFORTE QUARTET
- 5.0 AFTERNOON TOPICS: Mr. JAMES HARCOURT, 'Reminiscences of the Theatre'
- 5.15 THE CHILDREN'S HOUR
- 6.0 THE STATION PIANOFORTE QUARTET
- 6.30 S.B. from London
- 7.25 Prof. C. H. REILLY, 'Some Modern Buildings—The Streets of To-Day'
- 7.45-11.0 S.B. from London (9.10 Local News)

5NG NOTTINGHAM. 275.2 M.

- 11.30-12.30 Concert relayed from Daventry
- 3.45 LYON'S CAFÉ ORCHESTRA, conducted by BRASSEY EYTON
- 4.45 MUSIC and AFTERNOON TOPICS: The Rev. C. H. HODGSON, Literary Talk
- 5.15 THE CHILDREN'S HOUR
- 6.15 'A READER': 'New Books'
- 6.30 S.B. from London
- 7.25 S.B. from Liverpool
- 7.45-11.0 S.B. from London (9.10 Local News)

5PY PLYMOUTH. 400 M.

- 3.30 BROADCAST TO SCHOOLS: Mr. R. A. J. WALLING, 'Great Days in Newspaperland'
- 4.0 AFTERNOON TOPICS: Mr. A. C. STOCKWELL, 'Some Notes on Bird Life'
- 4.15 TEA-TIME MUSIC: THE ROYAL HOTEL TRIO, directed by ALBERT FULLBROOK
- 5.15 THE CHILDREN'S HOUR
- 6.0 WALTER BELGROVE (Baritone)
- 6.30 S.B. from London
- 7.25 S.B. from Liverpool
- 7.45-11.0 S.B. from London (9.10 Local News)

6FL SHEFFIELD. 272.7 M.

- 11.30-12.30 Gramophone Records (Dance Music)



Miss PHYLLIS PANTING is playing 'The Girl' in 'Guy Weatherby's Dilemma,' at Bournemouth at 7.45.

- 4.0 Afternoon Topics
- 4.15 SCHUBERT
Lecture-Recital by MABEL A. HAINSWORTH
GEORGE JEFFERSON at the Piano
Waltz in A Flat, Op. 9; Landler, Op. 67;
German Dance, Op. 33
The Wild Rose; The Erl King
Musical Moments, Op. 94, No. 6; The Wanderer;
Scherzo from Sonata, Op. 9; Peace
Impromptu, Op. 142, No. 2; The Young Nun;
Slumber Song; Impromptu in A Flat, No. 4
- 5.15 THE CHILDREN'S HOUR: 'More Musical Pictures made by Dream Lady'
- 6.0 Musical Interlude
- 6.30 S.B. from London



A VILLAGE STREET IN BENGAL.

Listeners will find that this characteristic view of an Indian village will help them to envisage the scenes of which Mr. W. E. Burrows will talk in the sixth of his 'travel pictures of the British Empire' this afternoon. [Manchester 3.25.]

- 7.25 S.B. from Liverpool
- 7.45-11.0 S.B. from London (9.10 Local News)

6ST STOKE. 294 M.

- 3.20 BROADCAST TO SCHOOLS: Mr. J. R. B. MASEFIELD, 'Nature Talk'
- 3.45 London Programme relayed from Daventry
- 5.0 AFTERNOON TOPICS: Miss M. DUKE, 'Some Village Sketches'
- 5.15 THE CHILDREN'S HOUR
- 6.0 Light Music
- 6.30 S.B. from London
- 7.25 S.B. from Liverpool
- 7.45-11.0 S.B. from London (9.10 Local News)

5SX SWANSEA. 294 M.

- 3.20 BROADCAST TO SCHOOLS: Mr. B. PERBOTT, F.R.A.S., 'Our Neighbours in Space—(VI) Our Neighbours at the Other End of the Street'
- 3.45 London Programme relayed from Daventry
- 5.0 Mr. D. RUY'S PHILLIPS, 'The Real St. David'
- 5.15 THE CHILDREN'S HOUR
- 6.0 'Country Dancing.' Talk with Music
- 6.30 S.B. from London
- 7.25 S.B. from Liverpool
- 7.45-11.0 S.B. from London (9.10 Local News)

Northern Programmes.

5NO NEWCASTLE. 312.5 M.

- 3.0—Prof. J. L. Morrison, 'Travellers' Tales of Many Lands.'
- 3.20—London Programme relayed from Daventry. 3.45—London Programme relayed from Daventry. 5.0—Miss Rollin, 'More About Weaving.' 5.15—Children's Hour. 6.0—Prudhoe Male Voice Quartet. 6.30—S.B. from London. 7.25—S.B. from Liverpool. 7.45-11.0—S.B. from London.

5SC GLASGOW. 405.4 M.

- 11.30-12.30—Gramophone Records. 3.0—Dance Music relayed from the Plaza. 3.20—Broadcast to Schools: Mr. Mortimer Batten, 'The Romance of Our Mountain Birds—The Grouse.' 3.32—M. Albert le Grip, 'French—L'Attrait du Pole.' Overture, 'The Magic Flute' (Mozart). 3.55—Afternoon Concert. Wireless Quartet. Christine Shepherd (Contralto). 5.0—Afternoon Topics: Hilda Ferris, 'Invalid Cookery.' Part II. 5.15—Children's Hour. 5.58—Weather Forecast for Farmers. 6.0—Classic Woodward (Pianoforte). 6.30—S.B. from London. 7.25—S.B. from Liverpool. 7.45-11.0—S.B. from London.

2BD ABERDEEN. 500 M.

- 3.30—Broadcast to Schools: Rev. A. Austin Foster, 'Shakespeare's "Tempest".' 3.45—Station Octet. 4.0—Mlle. Madeline Marot, 'Elementary French' (VII). 4.15—Station Octet. James Killis (Baritone). 5.15—Children's Hour. 6.0—'Bolshevik': 'Recent Events.' 6.15—For Farmers, by Mr. Don G. Munro. 6.25—Agricultural Notes. 6.30—S.B. from London. 6.45—Mr. Peter Craigmyle, 'Football Topics.' 7.0—S.B. from London. 7.25—S.B. from Liverpool. 7.45-11.0—S.B. from London.

2BE BELFAST. 306.1 M.

- 11.0-1.0—Concert relayed from Daventry. 3.0—Broadcast to Schools: Prof. R. M. Henry, 'What We Owe to Greece and Rome.' 3.30—Claude de Ville (Pianoforte Recital Series): Scenes from Childhood (Schumann). 3.45—London Programme relayed from Daventry. 4.45—Gramophone Records. 5.0—Afternoon Topics: Mrs. James Morwood, 'American Life in Retrospect' (IV). 5.15—Children's Hour. 6.0—London Programme relayed from Daventry. 6.30—S.B. from London. 7.25—S.B. from Liverpool. 7.45-11.0—S.B. from London.

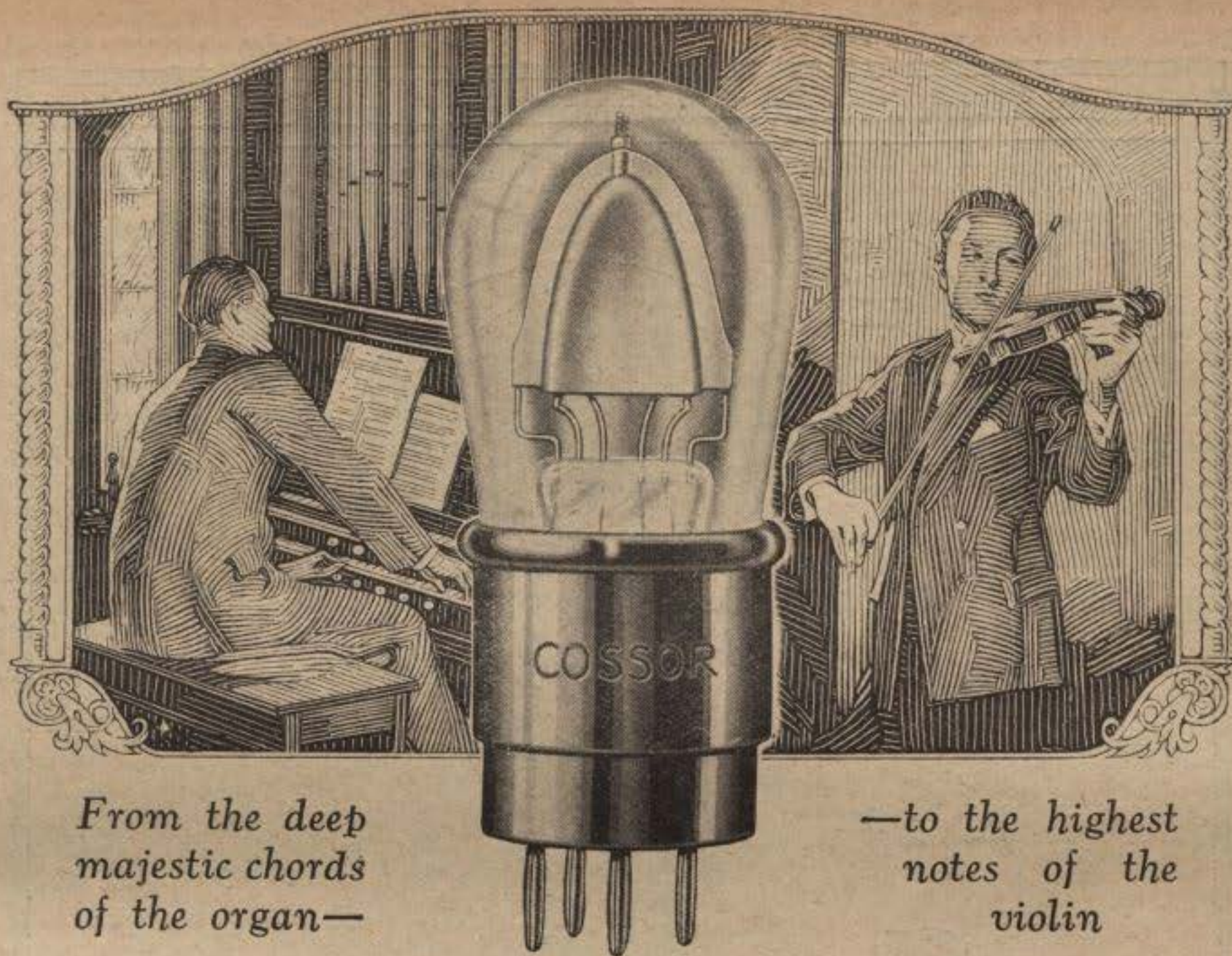

*From the deep
majestic chords
of the organ—*

*—to the highest
notes of the
violin*

—and every register in between—all reproduced with startling realism with the wonderful new Cossor 2-volt R.C. Valve

WIRELESS is undergoing a significant change. The latest trend is towards better tone. Quality of reproduction comes in the fore-front of every broadcast enthusiast's requirements. "Give me" he says "the voice of the living artiste—not a mechanical rendition." Ever since Broadcasting began tonal purity has been dependent upon the use of suitable L.F. Transformers. And very few Transformers are capable of giving an equal amplification of all frequencies. Even the most expensive ones lose entirely the very low notes. How,

then, can radio approximate to the original when a considerable proportion of the lower registers are missing?

But now a big change is afoot. Transformers will soon be things of the past. Experimenters have long since known that choke or resistance coupling, besides being much cheaper, gives a perfectly even amplification of every note in the harmonic scale.

But one thing has been lacking—a suitable valve. At last even this difficulty has been removed. The wonderful new

Cossor 2-volt R.C. is the solution to this 3-year-old problem. This valve—with an impedance of only 75,000 ohms. has a record amplification factor of 40—the highest yet attained. While its consumption at 1·8 units is only 1 ampere.

Convert your Receiver at once and enjoy the living naturalness and the true beauty of every instrument—and of every voice. The cost is but little—the reward of your labour is great indeed. But be sure you use the new Cossor R.C.—no other valve has the Kalenised filament which is the real secret of its wonderful **14/-** powers of reproduction.

The new COSSOR R.C. Two

PLAYER'S MEDIUM NAVY CUT CIGARETTES WITH OR WITHOUT CORK TIPS.



for Cool Smoking



PLAYER'S

Navy Cut

CIGARETTES

10 for 6d. 20 for 11½d.
 50 for 2/5 100 for 4/8



N.C.C.40

PROGRAMMES FOR SATURDAY (February 26)

2LO LONDON. 361.4 M.

- 3.0 POPULAR ORCHESTRAL PROGRAMME
MARY LOHLEN (Soprano)
GEORGE PIZZEY (Baritone)
THE WIRELESS ORCHESTRA
Conducted by
JOHN ANSELL
- 3.40 WALES v. FRANCE
A Running Commentary on the
Second Half of the
INTERNATIONAL RUGBY MATCH
S.B. from Swansea
- 4.45 POPULAR ORCHESTRAL PROGRAMME (Continued)
- 5.0 Mrs. MARION CRAN, 'A Garden Chat'
- 5.15 THE CHILDREN'S HOUR: THE DAVENTRY QUARTET; 'A Fairy Tale Up to Date,' by A. J. Alan; 'Pattern Weaving on Bells' (with Handbell Illustrations by Mrs. Hughes), by William Roughton
- 6.0 THE LONDON RADIO DANCE BAND, directed by SIDNEY FIRMAN
- 6.30 TIME SIGNAL, GREENWICH; WEATHER FORECAST, FIRST GENERAL NEWS BULLETIN
- 6.45 THE LONDON RADIO DANCE BAND (Continued)
- 7.0 Mr. SANTOS CASANI
- 7.15 SCHUMANN'S 'MYRTLES'
Sung by DALE SMITH

The last evening of our week of Schumann is devoted to the last seven songs of the *Myrthen (Myrtles)* cycle.

XX. *Wie kann ich froh und munter sein?* (O how can I be blithe and glad?) This is Burns' song about the bonnie lad who is 'o'er the hills and far away.'

XXI. *Was will die einsame Träne?* (What means the solitary tear?) The poem, by Heine, speaks of a sorrow that cannot, like other passing griefs, be wept over and then forgotten. This sorrow is deeper and keener—love itself has departed like a breath.

XXII. *Niemand.* (Nobody.) A characteristically independent pronouncement of Burns. 'I am naebody's lord,' says he, and 'I'll be slave to naebody.' 'Naebody cares for me,' is the conclusion, and so 'I care for naebody.'

XXIII. *Am Westen.* (In the West.) The last Burns piece in this cycle. The maid, as she goes to rest, looks not to North, South or East, for

Far in the West lives he I lo'e best,
The lad that is dear to my babie and me.

XXIV. *Du bist wie eine Blume.* (How like a flower thou art.) This is one of the three or four most popular Schumann songs. It is a sweet moment of musing upon one who is pure and fair, whose beauty arouses sweet sadness in the heart.

XXV. *Aus den ostlichen Rosen.* (Roses from the East.) The words are by Ruckert. A lover sends roses to a rosy-cheeked one—a message of spring to one in whose eyes lurks the joy of spring.

XXVI. *Zum Schluss.* (The End.) A parting word (of Ruckert) to the 'Sister Bride,' for whom the lover has woven this imperfect garland of myrtle. Some day, in God's goodness (he ends), perfect love shall weave for her the perfect wreath.

7.25 Mr. HERBERT CHAPMAN, 'Football League Club Worries'

A BIG club in the First Division of the Football League is now a large-scale financial con-

cern, depending for its success primarily on the efficiency of an equally intricate human machine—the team. Managing a team that is to play right through a long, hard season, with such incidental excitements as Cup-ties and such complications as transfers and casualties, is a very arduous, expert and responsible job, and one of which Mr. Chapman, who is manager of the great London club, The Arsenal, is well qualified to speak.

- 7.45 A VARIETY PROGRAMME
THE RAMBLERS
in Spots of Harmonized Syncopation
TOM CLARE
(Entertainer at the Piano)
LOTTIE VENNE (the famous Comedy Actress)
ETHEL BAIRD and REX EVANS
in a Pot-Pourri of Melody and Talk
The Comperes who can never agree—
CLAPHAM and DWYER

8.45 LESLIE ENGLAND (Pianoforte)
Etude in A Flat } Chopin
Scherzo in B Flat Minor }

9.0 TIME SIGNAL, GREENWICH; WEATHER FORECAST, SECOND GENERAL NEWS BULLETIN; Local Announcements

9.15 Mr. BASIL MACDONALD HASTINGS reading a Short Story

TO-NIGHT'S instalment of the series of Modern Humorists is supplied by a versatile and always amusing essayist, playwright and journalist. Mr. Macdonald Hastings has published several books of essays and is the author, or part-author, of many plays, including *The Happy Ending*, *Razle-Dazle*, *Victory*, *If Winter Comes*, and *Hanky-Panky John*. In addition, he was the founder of that lively production, 'Roosters and Fledglings,' the Air Force magazine.

- 9.30 THE EASTBOURNE MUNICIPAL ORCHESTRA
Under the direction of
Captain H. G. AMERS
BLANCHE ALLEN (Soprano)
Relayed from
DEVONSHIRE PARK, EASTBOURNE
Miniature Suite Eric Coates
A Night on the Bare Mountain Moussorgsky
BLANCHE ALLEN (Soprano)
My Dearest Heart Sullivan
ORCHESTRA
Excerpts from 'Merric England' Edward German
BLANCHE ALLEN
'Homing' Del Riego
ORCHESTRA
The Swan ('The Animal's Carnival')
Saint-Saëns
Rustle of Spring Sinding
Menuet Paderewski

10.30-12.0 DANCE MUSIC
THE SAVOY ORPHEANS and THE SYLVIANs, from the Savoy Hotel

5XX DAVENTRY. 1,600 M.

- 10.30 a.m. TIME SIGNAL, WEATHER FORECAST
- 3.0 *S.B. from London*
- 3.40 WALES v. FRANCE
Second Half of the
INTERNATIONAL RUGBY MATCH
S.B. from Swansea
- 4.45 *S.B. from London*
- 9.10 Shipping Forecast
- 9.15-12.0 *S.B. from London*

5IT BIRMINGHAM. 326.1 M.

- 3.0 London Programme relayed from Daventry
- 3.40 WALES v. FRANCE
INTERNATIONAL RUGBY MATCH
Relayed from Daventry
- 4.45 AFTERNOON TOPICS: MARGARET DANGERFIELD: 'Twentieth Century Travel—By Stage Coach, Train and Motor-Diligence.' DORIS BEESLEY (Soprano)
- 5.15 THE CHILDREN'S HOUR: 'Snooky Adventure,' by Phyllis Richardson. Songs by DORIS BEESLEY (Soprano) and EVA BLACKMOOR (Contralto)
Mr. ARTHUR KENNEDY: Music Talk (with Illustrations): 'The Viola'
- 6.0 LOZELLS PICTURE HOUSE ORCHESTRA, conducted by PAUL RIMMER
March, 'Florentiner' Fuell
Selection, 'Irene' Tierney
- 6.30 *S.B. from London*
- 7.45 THE SATURDAY NIGHT REVUE
(Second Instalment)
Book and Lyrics written and the Revue produced by GRAHAM JOHN
Music by VIVIAN ELLIS, H. M. TENNENT, and MAX DAREWSKI
Additional number by IRVING KING

The Cast includes:

Geoffrey Gwyther, Florence Oldham, Tommy Handley, Nadine March, Henry Caine, The Radio Chorus and Blanche Tomlin

In the following items:

- Opening Chorus—'Make It Saturday Night'
- Introducing the Company
- Duet, 'Start Caring'
- The Big Snag, 'A Dip in the Post-Bag'
- Duet, 'Moonshine'
- Trio, 'Don't Tell Mother'
- Sketch, 'The Best Man'
- Song, 'Tango Tune'
- Sketch, 'The Last Laugh'
- Dancing Song, 'Follow Me'
- Song, 'Rolling Stone'
- Sketch, 'A Thief in the Night'

- Duet, 'The Whole Town's Talking'
- Sketch, 'Spring in Arcady'
- Quartet, 'Be a Sport!'
- Talk, 'Fixing the Coop Oop'
- Duet, 'When You and I were Dancing'
- Burlesque, 'The Missing Links'
- Anthem, 'The More We Are Together'
- Finale, 'Make It Saturday Night'

THE RADIO DANCE BAND, directed by SIDNEY FIRMAN



LONDON'S VARIETY BILL TO-NIGHT.

These variety favourites will broadcast from London this evening at 7.45. On the left is Miss Ethel Baird, who, with Mr. Rex Evans, will give a pot-pourri of melody and talk; in the centre are Clapham and Dwyer, who will, as usual, fail to agree; and on the right is Miss Lottie Venne.

PROGRAMMES FOR SATURDAY (February 26)

8.45 S.B. from London (9.10 Local News)

9.30 POPULAR PROGRAMME

THE STATION ORCHESTRA
Overture, 'Light Cavalry' *Suppé*
LEONARD LOVESEY (Tenor)
The Late Player *Peel*
The Jolly Tinker *arr. Newton*
The English Rose from 'Merrie England' *German*
THE song in praise of *The English Rose* is sung
in Edward German's Opera by Sir Walter
Raleigh. Thus it runs:—

Dan Cupid hath a garden
Where women are the flowers.
The fairest Queen, it is, I ween
The perfect English rose!

ORCHESTRA

Suite, 'Peer Gynt' *Grieg*
Morning; Death of Ase; Dance of Anitra;
In the Hall of the Mountain King



Mr. Edward Hill, baritone, and Miss Marjorie Scoon, contralto, will sing for the delectation of Bournemouth listeners to-night at 8.0.

MIRA JOHNSON (Entertainer)

Asking Papa *Scott Gordon*
The Wail's Paradise *Ferria Carlton*
Charm *Lawrence Baskcomb*

ORCHESTRA

Gavotte, 'The Bells of St. Malo' *Rimmer*
LEONARD LOVESEY
Flower and Star *Fisher*
An Old-Style Rhyme *arr. Hunt*
A Farewell *Liddle*

MIRA JOHNSON

Only Seven *Lillian Grey*
When a Girl's in Love *Kenneth Duffield*

ORCHESTRA

March, 'Admirals All' *Bath*

10.30-12.0 S.B. from London

6BM BOURNEMOUTH. 491.8 M.

11.15-12.15 MIDDAY MUSIC by F. G. BACON'S
ORCHESTRA, relayed from W. H. Smith and Son's
Restaurant, The Square

3.0 London Programme relayed from Daventry

3.40 WALES v. FRANCE

INTERNATIONAL RUGBY MATCH
Relayed from Daventry

4.45 THE ROYAL BATH HOTEL DANCE BAND,
relayed from King's Hall Rooms. Directed by
ALEX. WAINWRIGHT

5.0 London Programme relayed from Daventry

5.15 THE CHILDREN'S HOUR

6.0 THE WIRELESS TRIO: REGINALD S. MOUAT
(Violin); ARTHUR MARSTON (Pianoforte); W.
E. GILL (Horn)

Horn Trio in E Flat, Op. 40 *Brahms*

6.30 S.B. from London

7.45 THE STATION OCTET

Suite, 'A Coon's Day Out' *Baynes*

8.0 MAJORIE SCOON (Contralto), EDWARD HILL
Baritone)

Selected Items

8.10 OCTET

Entr'actes:

The Wedding of the Rose *Jessel*
Moresque *Coates*
Merry Nigger *Squire*

8.25 MARJORIE SCOON and EDWARD HILL

In further selections

8.35 OCTET

Valse, 'The Gipsy Princess' *Kalman*

8.45-12.0 S.B. from London (9.10 Local News)

5WA CARDIFF. 353 M.

3.0 London Programme relayed from Daventry

3.40 WALES v. FRANCE

A Running Commentary on the International
Rugby Match at Swansea
Relayed from Daventry

4.45 London Programme relayed from Daventry

5.0 THE DANSANT: Music by the LONDON
CHORDEANS, relayed from Cox's Café

5.15 THE CHILDREN'S HOUR

6.0 London Programme relayed from Daventry

6.30 S.B. from London

7.0 Capi, A. S. BURGE: 'International Rugby
Gossip'

7.15 S.B. from London

7.45 WAR-TIME REMINISCENCES

THE STATION ORCHESTRA

Madelon

JOHN RORKE

Where the Black-eyed Susans Grow
Kitty the Telephone Girl (Hello Tango)

ORCHESTRA

Roses of Picardy *Haydn Wood*

JOHN RORKE and ELSIE CORAM

I've Got Everything I Want But You (The
Passing Show)

Didn't Know the Way To (Arlette) *Novello*

ORCHESTRA

Selection from 'The Lilac Domino' *Cuvillier*

JOHN RORKE

I'm On the Staff (Arlette) *Novello*

ELSIE CORAM

Widows Are Wonderful (Yes, Uncle)

Nat. D. Ayer

JOHN RORKE

Till the Boys Come Home *Ivor Novello*

ORCHESTRA

When You Come Home, Dear *Squire*

JOHN RORKE and ELSIE CORAM

Some Sort of Somebody (Vanity Fair)

Herman Finck

We'll Have a Little Cottage (Bubbly)

Philip Braham

ORCHESTRA

March, 'The Contemptibles' *Stanley*

The Dawn of Victory *arr. Pether*

8.45 DORIS PALMER

(Comedienne)

9.0-12.0 S.B. from London (9.10 Local News)

2ZY MANCHESTER. 384.6 M.

3.0 London Programme relayed from Daventry

3.40 WALES v. FRANCE

A Running Commentary on the International
Rugby Match at Swansea
Relayed from Daventry

4.45 Dance Music: THE ELYSÉE FIVE, from the
Piccadilly Danse Salon

5.0 HELENA CECILE (Entertainer)

Colds *Tom Clark*
Lil' Feller *King*
Oh, But I Wish I Were a Man *Rome*
Some Popular Imitations

5.15 THE CHILDREN'S HOUR: Requests

6.0 Light Music

6.30 S.B. from London

6.45 Light Music

6.50 For Scouts

7.0 S.B. from London

7.25 Mr. F. STACEY LINTOTT: Sports Talk

7.45 A POPULAR PROGRAMME

THE STATION ORCHESTRA

Overture, 'Zampa' (By Request) *Hérold*

Suite, 'A Day in Naples' *Byrg*

GLADYS PALMER (Contralto)

I Sometimes Think (In a Persian Garden)

Liza Lehmann



Mr. John Rorke and Miss Elsie Coram sing in the programme of War-Time Reminiscences from Cardiff at 7.45 to-night.

When All Was Young (Faust) *Gounod*
Allah Be With Us *Woodforde-Finden*

ORCHESTRA

Selection, 'Queen High' *Genster*

GLADYS PALMER

The Land of Heart's Desire } *arr. Kennedy-Fraser*

An Eriskey Love Lilt } *arr. Lawson*

Turn Ye to Me (Songs of the North) *arr. Lawson*

ORCHESTRA

Simple Avenu *Thomas*

Overture to 'Raymond' (By Request) *Thomas*

9.0 S.B. from London (9.10 Local News)

9.30 MUSIC FROM THE SOUTH SEAS

LEO MORGAN'S HONOLULU QUARTET:

LEO MORGAN; T. ROGERS; W. KAMOKU;
J. HANDLE-HENRICKS

KAMOKU and QUARTET

Wiki-Wiki (On the Beach at Waikiki)

LEO MORGAN and his Ukulele

Pretty Little Baby

KAMOKU and ROGERS (Guitar and Steel Guitar)

Kohala (Hawaiian Traditional March) (Accom-
panied by Ukuleles)

HARRY HOPEWELL (Baritone)

Croon, Croon, Underneath the Moon .. *Clubsam*

The Little Octoroon *Stuart*

Little Alabama Coon *Hattie Starr*

WALLY READ (Banjo)

A Darkey's Romance *Grimshaw*

LEO MORGAN and QUARTET

Rose of Honolulu *Original*

KAMOKU and ROGERS (Guitar and Steel Guitar)

O Sole Mio

LEO MORGAN and QUARTET

Aloha Oe (Farewell To Thee) *Liliuokalani*

(Continued on page 392.)

In the first "Daily Mail" Ballot £25,000 in prizes was won by competitors and £87,000 was raised for the Hospitals by the British Charities Association. Enter to-day for the

Daily Mail IDEAL HOME BALLOT

The Second "Daily Mail" Competition.
(Organised by the British Charities Association)

TO HELP THE HOSPITALS

Send 2/6 for a Ticket TO-DAY. It may mean £5,000 in cash to you or an Ideal Home of your own—complete with site, furniture and house-keeping money for life.

All you have to do in this simple competition is to arrange sixteen given features of an Ideal Home in their order of popularity. Ask your wife about it. Talk it over with a friend—and make up your mind to be a prize winner. Send for as many tickets as you can afford.

£10,000 in **PRIZES**

Guaranteed by the "Daily Mail."

FIRST PRIZE

AN IDEAL HOME

AND £3 A WEEK FOR LIFE.

The Ideal Home consists of a
£1,500 House on a £250 Site with
£750 worth of Furniture—OR

£5,000 IN CASH

at winner's option.

2ND £1500 3RD £500

4TH £250

5 PRIZES OF £100 25 PRIZES OF £10
10 PRIZES OF £50 1,500 PRIZES OF £1

BALLOT TICKETS, 2/6 - 5 FOR 11/-

From Shops, Finlay's Tobacco Kiosks, or

POST THIS COUPON

To The British Charities Association
Kingsway House, 103, Kingsway, London, W.C.2.

I enclose £.....s.....d. Please send me
..... DAILY MAIL Ideal Home Ballot Tickets.

Name

Address

R.T.1

INFLUENZA

How does the Doctor fight it?

First, with ASPIRIN.

It is time the Public were told a few plain truths about Aspirin. Aspirin is Acetylsalicylic Acid: no more, no less. Users of the tablets can

1. Be beguiled by sensational advertisements into buying an ordinary Product under a fancy name, believing it to be a miracle-worker and pay an exorbitant price for what are actually only the regular Tablets of commerce.
2. Yield to the temptation to buy unbranded Tablets of unknown and often foreign origin, and, by saving a few pence, run the risk of getting short-weight, impure Tablets, some of which have been proved to have no effect at all on the human body except to upset the digestion.
3. Buy at a reasonable price.

HOWARDS' ASPIRIN TABLETS

(Sales over 1,000,000 a week.)

which are guaranteed to contain the full dose of Howards' Pure, genuine, English Aspirin, skilfully compressed and proved by an enthusiastic clientele not to upset the digestion, and to be

SAFE AND REALLY EFFICIENT

Safeguard your health, your pocket and your country.

These columns show the steady increase in the sales of Howards' Aspirin Tablets.

OF ALL HIGH-CLASS CHEMISTS.

Sole Manufacturers:

HOWARDS & SONS, LTD., ILFORD.

130 years' unblemished reputation for the purity of their products.



PROGRAMMES FOR SATURDAY (February 26)

(Continued from page 390.)

HARRY HOPEWELL
I Want You, Ma Honey Templeton
The Lily of Laguna Stuart
Ma Curly-Headed Babby Clusam

WALLY READ
Savoy American Medley arr. Somer

10.30-12.0 S.B. from London

6KH HULL. 294 M.

3.0 London Programme relayed from Daventry
4.45 AFTERNOON TOPICS: Mr. M. A. R. HOBSPOLL, 'Drama Through the Ages—(11) The Stage of To-Day'
5.0 FIELD'S QUARTET, relayed from the New Restaurant, King Edward Street
5.15 THE CHILDREN'S HOUR
6.0 London Programme relayed from Daventry
6.30-12.0 S.B. from London (9.10 Local News)

2LS LEEDS-BRADFORD. 277.8 M. & 252.1 M.

11.30-12.30 FIELD'S CAFÉ ORCHESTRA, relayed from Field's Café, Commercial Street, Leeds
3.0 London Programme relayed from Daventry
4.45 THE TROCADERO DANCE BAND, relayed from the Trocadero Ballroom, Bradford
5.0 AFTERNOON TOPICS: Petronius: 'Alice' (Continued)
5.15 THE CHILDREN'S HOUR: Choir Boys of St. Bartholomew's Church, Armley, Leeds. Conducted by HERBERT BARDGETT, F.R.C.O.: Lo. Country Sports (Weeks); While the Bright Sun (Byrd); Now is the Gentle Season (Morley)
6.0 Light Music
6.30-12.0 S.B. from London (9.10 Local News)

6LV LIVERPOOL. 297 M.

2.30 COMMUNITY SINGING organized by the Liverpool Daily Courier
3.0 LIVERPOOL v. NEWCASTLE UNITED
A Running Commentary on the Association League Match, by Mr. ERNEST EDWARDS ('Bee'), relayed from Anfield Football Ground
4.35 MONTAGUE'S SYMPHONICS relayed from the Edinburgh Café Ballroom
5.0 AFTERNOON TOPICS: CHARIS BROPHY, 'Domestic Economics'
5.15 THE CHILDREN'S HOUR
5.45 A SHAKESPEAREAN RECITAL by ROBERT SPEIGHT, of the Liverpool Playhouse Company 'Shakespeare the Poet'
Short Extracts from:
Twelfth Night; A Midsummer Night's Dream; The Merchant of Venice; A Winter's Tale; Measure for Measure; The Sonnets
Selections from 'Macbeth'
Speech from Act I, Scene 7; The 'Dagger' Speech; Speeches from Act V, Scenes 3 and 5
Mark Antony's Oration (Julius Caesar)
6.10 MONTAGUE'S SYMPHONICS, relayed from the Edinburgh Café Ballroom
6.30-12.0 S.B. from London (9.10 Local News)

5NG NOTTINGHAM. 275.2 M.

11.30-12.30 Gramophone Records
3.0 London Programme relayed from Daventry
4.45 SAM G. ROSS and his BAND, relayed from the Palais de Danse
5.0 THE CHILDREN'S HOUR
6.15 MABEL HODGKINSON (Pianoforte)
6.30-12.0 S.B. from London (9.10 Local News)

5PY PLYMOUTH. 400 M.

11.0-12.0 GEORGE EAST and his QUARTET, relayed from Popham's Restaurant
3.0 London Programme relayed from Daventry
4.45 Afternoon Topics
4.50 TEA-TIME MUSIC: THE ROYAL HOTEL TRIO, directed by ALBERT FULLBROOK
5.15 THE CHILDREN'S HOUR
6.0 GEORGE EAST in a Violin Recital
6.30-12.0 S.B. from London (9.10 Local News)

6FL SHEFFIELD. 272.7 M.

3.0 London Programme relayed from Daventry
4.45 ORCHESTRA relayed from the Grand Hotel
5.15 THE CHILDREN'S HOUR
6.5 F. R. STANTON, Eye Witness Account of the Match, SHEFFIELD UNITED v. CARDIFF CITY
6.20 Musical Interlude
6.30-12.0 S.B. from London (9.10 Local News)

6ST STOKE. 294 M.

3.0 London Programme relayed from Daventry
5.0 AFTERNOON TOPICS: MISS M. FRANCE: An Aunt Maria Sketch entitled, 'Mrs. Miggs and the 'Flu''
5.15 THE CHILDREN'S HOUR
6.0 Light Music
6.30-12.0 S.B. from London (9.10 Local News)

5SX SWANSEA. 294 M.

3.0 WALES v. FRANCE
A Running Commentary on the International Rugby Match
Relayed from St. Helen's Football Ground, Swansea
4.45 London Programme relayed from Daventry
5.15 THE CHILDREN'S HOUR
6.0 T. D. JONES (Pianoforte)
6.30 S.B. from London
7.25 Mr. J. C. GRIFFITHS-JONES: 'Swansea Town v. Portsmouth'
7.45 S.B. from London
8.45 S.B. from Cardiff
9.0-12.0 S.B. from London (9.10 Local News)

Northern Programmes.

5NO NEWCASTLE. 312.5 M.

11.30:—Mabel Hatfield (Soprano), William Bradshaw (Xylophone). 12.10-12.30:—Gramophone Records. 3.0:—London Programme relayed from Daventry. 4.45:—Music from Tilley's Restaurant, Blackett Street. 5.0:—A Garden Chat. London Programme relayed from Daventry. 5.15:—Children's Hour. 6.0:—Station Octet: A Children's Overture (Quilter); Walking Tune (Grainger); Sérénade d'Antoine (Chaminade); The Whispering of the Flowers (Blau); Minuet (Don Giovanni) (Mozart). 6.30:—S.B. from London. 7.25:—Mr. Alan Thompson, President of the Northumberland Rugby Union. 'Rugger'. 7.45:—The Saturday Night Revue (Second Instalment). 8.45:—S.B. from London. 9.30:—Band of the Tyne Division, R.N.V.R., conducted by E. White. F. Kemp Jordan (Baritone). 10.30:—Dance Music. Tilley's Dance Band relayed from the Grand Assembly Rooms. 11.15-12.0:—S.B. from London.

5SC GLASGOW. 405.4 M.

2.30:—Celtic v. St. Mirren. A Running Commentary on the Match relayed from Celtic Park, Glasgow. 4.30:—Jeffries' Orchestra relayed from the Locarno Dance Salon. 5.0:—Afternoon Topics. 5.15:—Children's Hour. 5.58:—Weather Forecast for Farmers. 6.0:—Jeanne Paule and Leonie Laseelles: Harmony, Syncopation and Comedy Duets. 6.30:—S.B. from London. 7.25:—An Old International, 'Association Football'. 7.45:—The Saturday Night Revue (Second Instalment). 8.45-12.0:—S.B. from London.

2BD ABERDEEN. 500 M.

3.0:—London Programme relayed from Daventry. 4.45:—Station Octet. Marjory Lorimer (Mezzo-Soprano). 5.15:—Children's Hour. 6.0:—Music by the Station Octet. 6.30-12.0:—S.B. from London.

2BE BELFAST. 306.1 M.

3.0:—Ireland v. Scotland International Association Match.—A Running Commentary, relayed from Windsor Park. 4.45:—Harry Dyson (Flute), Harry Marshall (French Horn). 5.0:—Afternoon Topics: Capt. T. O. Corrin, 'The Music of Other Lands' (4). 5.15:—Children's Hour. 6.0:—London Programme relayed from Daventry. 6.30:—S.B. from London. 7.45:—Variety. Station Orchestra. Mabel Constanduros (Entertainer). 9.0-12.0:—S.B. from London.

FOR LISTENERS TO OPERA BROADCAST.

On Friday of this week, we are broadcasting the seventh of our series of Opera for which libretti are being published. The Opera is to be 'ORPHEUS,' by Gluck. The advantages of having the book of words in front of you when listening to the opera are now appreciated by 100,000 listeners, and those who have not yet sent for a copy of this libretto, or are not on our list of regular subscribers, are advised to make immediate application on the form below. The price of the booklet is 2d. post free.

Please send me
stamps value

copy (copies) of the libretto of 'ORPHEUS.' In payment I enclose
at the rate of 2d. per copy.

PLEASE WRITE IN BLOCK LETTERS.

NAME

ADDRESS

Applications must be marked 'Libretti' on the envelope, and sent, together with the remittance, to Broadcast Opera Subscription List, c/o B.B.C., Savoy Hill, London, W.C.2.

Additional names and addresses may be written on a separate sheet of paper, but payment for the additional subscriptions must, of course, be sent with the order.

The Operas which have already been broadcast are 'Rigoletto,' 'The Bohemian Girl,' 'Faust,' 'The Barber of Seville,' 'Martha,' and 'The Red Pen,' and copies of these may also be had on application at the same price, i.e., 2d. per copy.

STERLING LOUD SPEAKERS

Each "Sterling" loud speaker is in the front rank of its particular class. The "Sterling" range includes so wide a variety of designs—each offering its individual characteristics in presenting wireless entertainment—that, whatever your personal inclination, satisfaction is definitely assured. Write for Booklet 364G, which describes and illustrates the complete range of Marconiphone and Sterling radio apparatus.

THE MARCONIPHONE
COMPANY, LIMITED,

(Sole Agents for Sterling
Telephone & Electric Co., Ltd.)



Head Office:
210-212, Tottenham Court Road,
London, W.1.
Registered Office:
Marconi House, Strand, London, W.C.2.



STERLING
"TYPE 32"
Reproduces with
great volume, accu-
rately rendering the
tones and overtones,
which are insepara-
ble from the
natural beauty of
music.

105/-

				
Gives ample volume. For home or public use. 75/-	The most popular of all junior loud speakers. 47/6	Horalees model. Extremely artistic and mellow in tone. 45/-	"The little fellow with the loud voice." 30/-	"The Very Soul of Music." 105/-
"AUDIVOX"	"BABY"	"MELLOVOX"	"DINKIE"	"PRIMAX"

MPO-0100

Learn why thousands of men are flocking to this new shaving creation

Accept, please, a 10-day tube to try

GENTLEMEN:—Your present shaving soap may be exactly fitted to your needs—or, it may be failing in one of five important ways.

Shaving is so important a thing in your life that it will pay you, we believe, to find out whether or not you are getting the utmost in a shaving cream.

5 mistakes corrected

- 1 Lather too scanty—Palmolive Shaving Cream multiplies itself in lather 250 times.
- 2 Slow action—Palmolive Shaving Cream acts in one minute. And makes a hard beard wax-like, soft.
- 3 Dries on face—The lather of Palmolive Shaving Cream maintains its creamy fullness for ten minutes on the face.
- 4 Hairs lie down—That is due to weak bubbles. Palmolive bubbles are strong—they hold the hair erect for the razor.
- 5 Skin irritations—The palm and olive oil content of Palmolive Shaving Cream leaves the face in fine condition.

Let us prove this

We ask your permission to prove these things—to send you a tube to try. Do us the kindness to mail this coupon, for your sake and for ours.



10 SHAVES FREE

Simply insert name and address and post to
The Palmolive Company (of England) Ltd.,
Dept. S.C., 21/23, Eagle St., London, W.C.1.

Name.....

Address.....

Please print name clearly Radio Times 18/2/27

P25

From all
chemists
and hair-
dressers.
Full-sized
Tube 1/6

IMPORTANT.

Injunction and Damages.

On the 13th January, 1927, in the High Court of Justice (Chancery Division), in the action of Marconi's Wireless Telegraph Company, Limited, against J. P. Pembroke, the Defendant consented to an Order restraining him from infringing the Plaintiff's Letters Patent 252 of 1914, 147147, 147148, 8821 of 1913, and 135177 and directing him to pay damages and costs.

The Super Heterodyne Receiver to which these proceedings relate was built by the Defendant with Bowyer-Lowe units.

WO104

A LOUD SPEAKER *with* EXPRESSION

*—and one with value
that wins, too.*

VALUE—a weighty word, meaning "full worth for the money you spend."

VALUE—everybody who buys a loud speaker should seek it.

VALUE—you can't have it without big production.

VALUE—you can't have it without concentrated production.

VALUE—YOU

*Get it in loud speakers
when you buy the
LISSENOLA*

Because: In the LISSENOLA LISSEN found the right type of sound-reproducing unit, and have concentrated on making it by the ten thousand, bringing costs down and putting up quality so high that nobody has yet succeeded in producing anything that compares with it for tone purity and power.

YOU GET A LOUD SPEAKER WITH EXPRESSION—ONE THAT WILL SATISFY YOU FOR EVER. MAKING EVERY PROGRAMME ENJOYABLE IF YOU GET THE LISSENOLA LOUD SPEAKER COMPLETE. TAKE ONE HOME ON OUR OFFER OF A

7 DAYS' TEST

Compare it against the most expensive loud speaker you can find—anything costing up to £20. If you do not definitely prefer the LISSENOLA for tone purity and power to any loud speaker you test it against, irrespective of price, sent it back within 7 days of purchase, and your money will be refunded in full. This offer also applies to the LISSENOLA Loud Speaking Unit if bought separately.

These parts can be purchased separately:

LISSENOLA Loud Speaking Unit..... 13/6

LISSENOLA Stand—takes an upright horn, home-built from the instructions given with each LISSENOLA unit..... 3/-

LISSENOLA Upright Horn. Big and powerful with 14in. flare. For those who already have the LISSENOLA Unit and want a handsome factory-made horn for it 17/6

LISSENOLA REED—no other loud speaker has this unique attachment, which adapts the LISSENOLA unit to so many loud speaker uses 1/-

LISSEN LIMITED,
300-320, FRIARS LANE, RICHMOND,
SURREY.

Managing Director: Thomas N. Cole.



*Golden-toned
for your
enjoyment.*

This is the
**LISSENOLA
LOUD SPEAKER**

The only full size, full powered loud speaker of high grade manufacture selling to-day.

Complete for.....

34/-

PEOPLE PREVIOUSLY PAID TOO MUCH FOR THEIR TRANSFORMERS—



YOU know it is much more difficult to make a transformer good and at the same time low in price than it is to make it good and high in price.

When the new LISSEN Transformer was first put on the market the people said: "It is too low in price—it can't be as good as they say it is." **BUT THERE MUST BE MANY PEOPLE NOW WHO PAID A HIGH PRICE FOR THEIR TRANSFORMERS AND WHO HAVE SINCE REGRETTED IT.**

REGRET AT PAYING 30/-

Here is a user of the new LISSEN Transformer who writes:—

Ref. 4150. 5/10/26.
Bognor.

"Last week my (naming a well-known transformer) broke down after 3 months. I happened to see your announcement of the new LISSEN so I decided to get one, and luckily, a trader in Bognor had some in stock. The results are really astonishing: volume and purity are perfect, and, furthermore, it seems to pick out each instrument in an orchestra so distinctly. In addition I am now able to get numerous foreign stations more clearly than before. In conclusion I can only say how sorry I am that I spent 30/- when I now have something better for 8/6."

LISSEN knew they had produced a remarkable transformer in the new one—and they immediately withdrew all the previous expensive LISSEN Transformers in favour of the new LISSEN. By putting into operation a new direct-to-dealer policy of distribution, too, which eliminated big

wholesale profits, LISSEN were able to offer the new transformer at a price which brought it within the reach of everybody. **SINCE THEN IT HAS SWEEPED THE MARKET.**

7 DAYS' TEST.

Test this new LISSEN as a transformer against the most expensive transformer, or as a Choke against the most expensive Choke you can find. If you do not definitely prefer the new LISSEN for tone purity and power to any other transformer and choke you test it against, irrespective of price, return it within seven days of purchase and your money will be willingly refunded.

NOT ONLY A GREAT TRANSFORMER BUT A GREAT CHOKE ALSO—USED EITHER WAY IT FULLY AMPLIFIES EVERY TONE, EVERY NOTE, EVERY HARMONIC, EVERY OVERTONE.

8'6

GUARANTEED FOR 12 MONTHS.

URNS RATIO3 to 1

RESISTANCE RATIO4 to 1

Use it for 1, 2 or 3 stages L.F. It is suitable for all circuits and all valves you will want to use.

There are many advertising manufacturers and all expect a share of the use and mention of their products in the sets published by the papers they advertise in. The best transformer is, therefore, not necessarily always used. **NO MATTER WHAT TRANSFORMER MAY BE SPECIFIED IN ANY CIRCUIT IT CAN BE REPLACED BY THE NEW LISSEN WITH AN IMPROVEMENT IN TONE AND VOLUME. REMEMBER THE 7 DAYS' TEST OFFER.**

LISSEN LIMITED, 300-320, FRIARS LANE, RICHMOND, SURREY.

Managing Director: THOMAS N. COLE.

HERE IS SOMETHING TO CONTROL YOUR SET 100 YARDS AWAY FROM IT—

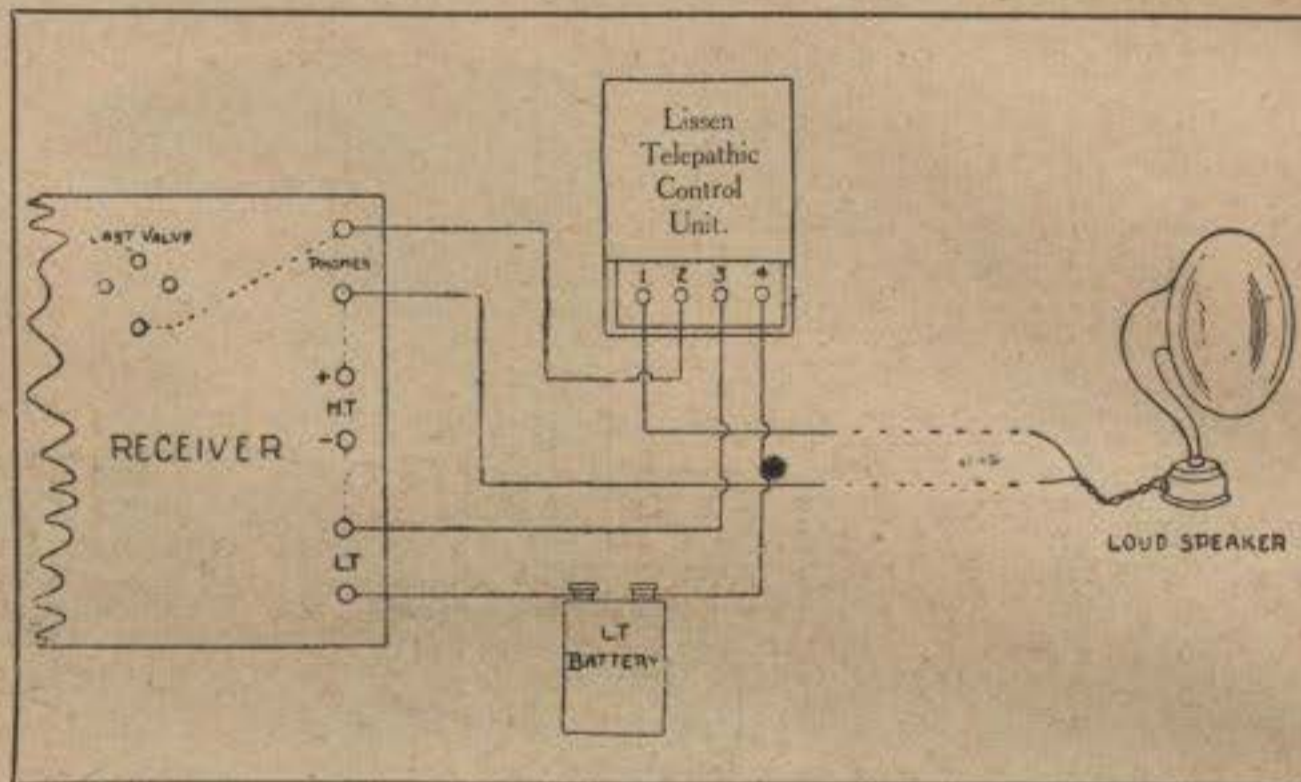
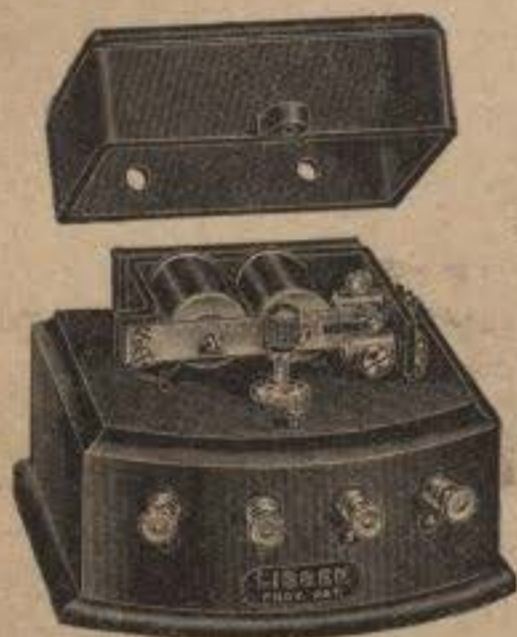

YOU are seated in a room with your loud speaker—your set is away at the back of the house. You are confined to your bedroom with a cold—your set is downstairs. Wouldn't it be a convenience you would appreciate if you could light up your valves and put them out, even though your set be 100 yards away? It sounds remarkable that this can be done, but with the LISSEN TELEPATHIC CONTROL connected to your receiver (a minute's job) you can do this. No extra wiring, no extra batteries needed—just the LISSEN TELEPATHIC CONTROL. You can have loud speaker points in every room, too, and the mere act of plugging in your loud speaker lights the valves on your set away in another room.

ENTHUSIASTICALLY APPROVED BY USERS—

The LISSEN TELEPATHIC CONTROL is a remote control device of a unique kind. When attached to any receiver it automatically switches on the filament current to the valves in the set merely by the act of connecting the usual leads to the loud speaker. By disconnecting one of the leads going to the loud speaker the valves on the set are automatically put out. Once the receiver is tuned there is no need to go to it at all to put the set into or out of use—this can be done at the loud speaker end.

The LISSEN TELEPATHIC CONTROL is sent out from the factory adjusted and ready for use. It will function on an anode current as low as .75 milliampere (most L.F. valves take about 2 milliamperes).

The Telepathic unit should be placed near the receiver and should be connected up according to the diagram above. The only point to be noted is that the plug telephone terminal on the receiver must be connected to one loud speaker lead. The other telephone terminal (which connects to the plate of the last valve on the receiver) is connected to No. 2 terminal on the LISSEN TELEPATHIC CONTROL.

Several plugging-in points may be arranged in different rooms, and the receiver will be automatically switched on when a loud speaker is connected to any one of them.

Arrangements are made for cutting out the control unit, and telephones can be connected to the receiver in the usual manner.

A LISSEN switch can be arranged to connect and disconnect. FULL INSTRUCTIONS GIVEN WITH EACH UNIT—consumes no current—costs nothing in replacements, and nothing to run.

LISSEN TELEPATHIC CONTROL - £2-10-0

(PATENTED)

(comes to you complete ready for connecting to any set, large or small it makes no difference).

A TONE AND VOLUME CONTROL FOR LOUD SPEAKERS—

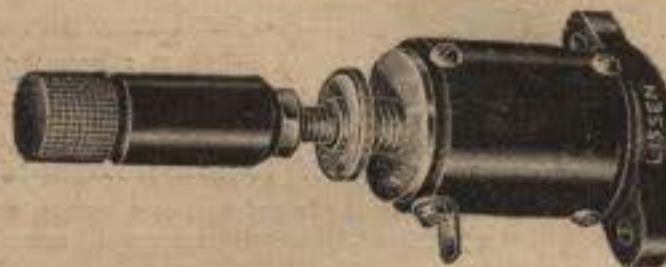

The LISSENOLA Loud Speaker and Loud Speaking Unit is capable of such volume that there may be times when you would like to tone it down. At other times you might want full volume. This LISSEN TONE CONTROL adjusts volume at the turn of a knob to suit your every wish. It has two terminals, and it is quite easy to fit it. You will see from the illustration that it can be mounted on a baseboard, for instance a piece of wood, outside the set, or run to any convenient position by means of a flexible cord.

LISSEN TONE CONTROL 4/-

(PATENTED)

(can be used for any make of loud speaker).

LISSEN GIVES YOU THE BEST PARTS IN RADIO AT PRICES WHICH REPRESENT FINE VALUE.

LISSEN LIMITED, 300-320, FRIARS LANE, RICHMOND, SURREY.

Managing Director: Thomas N. Cole.

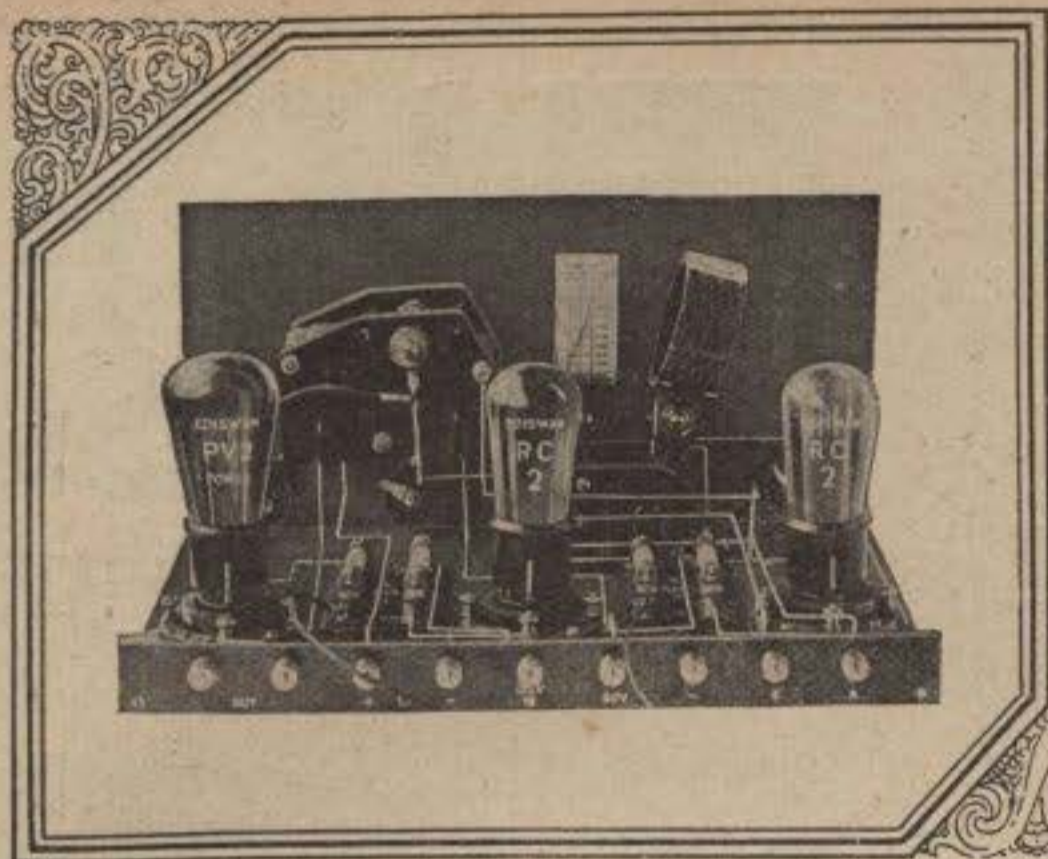

Have You
Built this
Remarkable Set?

The R.C. THREESOME

THE astounding popularity of the R.C. Threesome increases day by day.

Never has there been such national endorsement of a radio receiver never before have the superior advantages of Resistance-Coupling been so vividly convincing.

The tonal quality of the R.C. Threesome is a revelation. The deep, rolling bass notes of the organ come through unimpaired . . . the voice of the announcer

The VALVE
with the Window

With a filament glow so dull that an inspection window had to be provided . . . the new EDISWAN Quarter-Watt POINT ONE ECONOMY Valves are rapidly making history. Tonal purity, volume, strength in construction, current economy, and exceptionally long life . . . these are the features which make the new Ediswan Quarter-Watt Point One Economy Valves the nearest approach to perfection and for wireless reproduction at its best. Ask your dealer about these new types.

- 2-VOLT TYPES:
D.R.2. G.P.2.
DETECTOR. GENERAL PURPOSE.
R.C.2.
RESISTANCE COUPLING.

Use TYPE P.V.2. with above (and in all 2-volt stages) for LOUD SPEAKER Results.

is that of one standing behind you . . . every tone-shade is reproduced wonderfully pure and free from blast or blare.

And the R.C. Threesome is so easy to tune . . . one hand on the dial . . . that's all!

If you haven't built the R.C. Threesome, a revelation awaits you. *It is extremely easy to make . . . you can do it in an evening at a cost of only £3, or less.*

FREE BLUE PRINT & INSTRUCTIONS

Send for the simple-to-follow Blue Print and non-technically written Book of Instructions.

FILL IN COUPON—NOW!

EDISWAN

V.24.

Radio Times—18.2.27.

To THE EDISON SWAN ELECTRIC CO., Ltd,
(Publicity) 123/5 QUEEN VICTORIA STREET, LONDON, E.C.4.

Please send, post free, presentation copies of the "R.C. Threesome" Instruction Book and Blue-print.

Name

Address

PLEASE USE
BLOCK LETTERS

BUY DIRECT AND SAVE MONEY

BRANCHES:

- LONDON: 20 Store St., Tottenham Court Rd. (Museum 9200)
- BIRMINGHAM: 248, Corporation Street (Central 435)
- BRIGHTON: 31, Queen's Road (Brighton 899)
- BRISTOL: 36, Narrow Wine Street (Bristol 7972)
- CARDIFF: Domainions Arcade, Queen Street (Cardiff 7685)
- LEEDS: 65 Park Lane (Leeds 21479)
- MANCHESTER: 33, John Dalton Street (Central 1164)
- NEWCASTLE: 36, Grey Street (City 980)
- NOTTINGHAM: 30, Bridlesmith Gate (Nottingham 5551)
- TONBRIDGE: 34, Quarry Hill (Tonbridge 172)

7 DAYS APPROVAL Louden Valves, H.T. Batteries and accumulators excepted, all Fellows Products are sent on 7 days approval on receipt of full cash price. If you send them back undamaged your money will be returned without question.

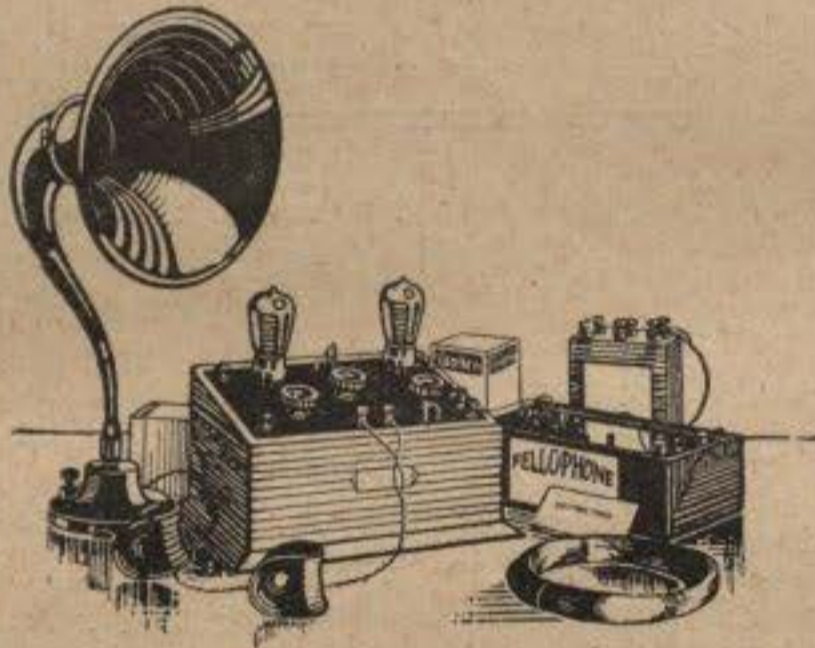

£6.15.0 LITTLE GIANT TWO COMPLETE

THESE are the famous Little Giant Sets which are selling in thousands in all parts of the country. They give clear and powerful reception of first-rate quality. Our files are full of enthusiastic letters of praise of these wonderful sets. They are complete in every detail.

Specification	Little Giant I.	Little Giant II.	Little Giant III.	Little Giant IV.
Receiver (including Marconi Royalty)	£2 2 6	£3 17 0	£4 12 0	£6 5 6
Louden 4-Volt D.E. Valves (1)	8 0	(2) 16 0	(3) £1 4 0	(4) £1 12 0
H.T. Battery (Fellophone) (54V)	6 6	(108V) 13 0	(108V) 13 0	(108V) 13 0
Fellows 4V. Accumulator (20ah)	12 6	(20ah) 12 6	(20ah) 12 6	(40ah) 16 6
Aerial, Insulators, Wiring, Instructions	3 0	3 0	3 0	3 0
Headphones (H) or Junior Loud Speakers (LS)	(H) 11 6	(LS) 13 6	(LS) 13 6	(LS) 13 6
Total Cash Price	£4 4 0	£6 15 0	£7 18 0	£10 3 6
Deferred Payments, With Order	24 6	38 4	44 9	57 0
6 Monthly Payments of	12 3	19 3	22 5	28 8

LONDON, BIRMINGHAM, BRIGHTON, BRISTOL, CARDIFF

BUY DIRECT AND SAVE MONEY

FELLOWS WIRELESS

PARK ROYAL, N.W.10

7/6

and there are no trade discounts.



H.T. BATTERIES

YOU get the full 7s. 6d. worth. This 60 volt H.T. Battery is not only the cheapest; it is the best H.T. Battery in the world. It is tapped every 3 volts and supplied complete with wander plugs.

Fellows Batteries are All British. They are completely made, not merely assembled, in England.

- 54 Volts with lead for grid bias.....post free 6s. 6d.
- 60 „ tapped every 3 volts and supplied complete with wander plugs post free 7s. 6d.
- 108 „ tapped every 6 volts and supplied complete with wander plugs post free 13s. 0d.

THE FELLOWS JUNIOR

A PERFECTLY lovely little instrument that astonishes and delights everyone who hears it. It fills an ordinary sized room with clear beautiful reproduction. Try it yourself on approval and you will understand why every post brings us letters of congratulation. 19" high, fitted with volume adjuster. Packing free, carriage forward.

THE VOLUTONE, the Junior's big brother, for dancing, large halls, etc., is 45/-. packing free, carriage forward.



13/6

BUY DIRECT AND SAVE MONEY
THE
LEADING BRITISH WIRELESS HOUSE

FOUR factors have made Fellows Wireless the leading wireless manufacturers of this country:

1. All our products are "high quality" products.
2. They are sold at prices far below any similar goods.
3. With the exception of Louden Valves, H.T. Batteries and accumulators, all our goods are sold on 7 days approval.
4. All our goods are British Made throughout. Selling direct to the public has made us a few enemies among traders, but it has made us hundreds of thousands of friends from the Public. We have no one to please but our clients and we shall continue to give them every advantage that high quality and low price can offer.



For 4 or 6 Volt Accumulators

45/-

For H.T. Accumulators

50/-

CHARGE YOUR OWN ACCUMULATORS

If you have Alternating Current (A.C.) Electric Light you can do all your own Accumulator Charging at a cost of about 10 hours for a 1d. at the most. The charger is simplicity itself and cannot harm either you or your electric light. Full instructions are sent with the charger which you can try for yourself on 7 days approval. There is also a special charger for H.T. Accumulators, price 50s.

NB.—When ordering state carefully voltage and frequency (cycles) of your main. You will find this information on your meter.

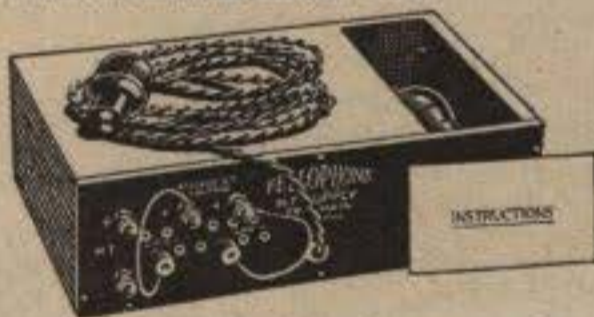

£4.10

H.T. MAINS UNIT

THIS entirely replaces the H.T. Battery. Simply plug into a lamp socket, switch on and an inexhaustible supply of H.T. current is at your disposal. The Mains Unit is just as safe to use as an ordinary electric lamp and its current consumption is actually much less!

They are made in two types whether for A.C. or D.C. Type B delivers separate values, two of which are variable over twelve tapplings, thus enabling the exact required voltages to be applied to several valves at once. (For further descriptions see pages 28 and 29 of our Catalogue No 10.)

A.C.	PRICES (Carriage forward)		D.C.
Type A (50 volts)	£3 10 0	Type A (50 volts)	£2 10 0
Type A (100 volts)	£3 10 0	Type A (70 volts)	£2 10 0
Type B (multi voltage)	£4 10 0	Type A (100 volts)	£2 10 0
		Type B (multi voltage)	£3 10 0

BUY DIRECT AND SAVE MONEY
Louden Valves



LOUDEN VALVES

WHEN all the talking is done the fact remains that Loudon Valves are in themselves as fine a valve as any you can buy. They will last as long, use as little current as the most expensive valve on the market and they will give you a silver clear purity of reception that is without flaw. They are made, like all our products, by British workpeople in a British factory. If you use Loudon Valves you will save money and you will get the finest reproduction you can ever have.

4/6 Bright Emitters. L.F. Amplifier F.1. H.F. Amplifier F.2. Detector F.3. 5.5 volts 0.4 amps.	8/- Dull Emitters. L.F. Amplifier LER.1. H.F. Amplifier LER.2. Detector LER.3. 2 volts 0.2 amps.	8/- Dull Emitters. L.F. Amplifier FER.1. H.F. Amplifier FER.2. Detector FER.3. 4 volts 0.1 amps.
9/- Dull Emitters. L.F. Amplifier F.E.R.1. H.F. Amplifier F.E.R.2. Detector F.E.R.3. 6 volts 0.1 amps.	11/- D.E. Power Valves. Transformer Amplifier P.E.R.1. Resistance Amplifier P.E.R.2. 4 volts 0.2 amps.	12/- D.E. Power Valves. Transformer Amplifier P.E.R.1. Resistance Amplifier P.E.R.2. 6 volts 0.2 amps.

Postage and Packing: 1 Valve 4d. 2 or 3 Valves, 6d. 4, 5 or 6 Valves, 9d.

This 48-page Catalogue is free on request.



It will give you full details of all our products so that you can see how our policy of "direct to the public" has given you the world's finest radio value.

M.C.307

LEEDS, MANCHESTER, NEWCASTLE, NOTTINGHAM, TONBRIDGE



PULLING TOGETHER

ARE your valves pulling together? Individually, they may be excellent; but what of their collective efficiency? Co-operation is just as important in the functioning of a wireless set as in the winning of a boat race. If you are using valves which, however good in themselves, were not designed for group operation, then you are not getting the best out of your set.

The two series of B.T.H. valves listed below have been designed expressly for group operation; the B5 group for 4 volt accumulators and the B4 group for 6 volt accumulators. The B5 and B4 valves are, of course, well known to be the most economical and efficient valves in their respective classes, and for the specific purposes for which they were designed. But by themselves they were incomplete and did not fully satisfy the needs of the multi-valve user. Now that the B5H and B6 have been added to the B5, and the B4H to the B4, there are available two complete groups of valves which will meet every requirement of the 4 volt and 6 volt user. Either group, according to the voltage of your battery, will give you *better* results than any other similar combination of valves.

Valve	Purpose	Fil. V.lts	Fil. Amps	Anode Vol's	Amplification Factor	Impedance	Price. s. d.
for 4v { B5H 5 B5	H.F.	2.8	0.06	40-120	17.5	55000 ohms	14 0
	Det.	2.8	0.06	20-80	7	17000 ohms	14 0
	Power L.F.	2.8	0.12	40-120	8	12000 ohms	18 6
for 6v { B4H B4	H.F. & Det.	6	0.25	60-150	20	28000 ohms	14 0
	Power L.F.	6	0.25	40-120	6.5	6000 ohms	18 6



RADIO VALVES

Use B.T.H. Valves for efficient team work

The above prices are applicable in Great Britain and Northern Ireland only

THE BRITISH THOMSON-HOUSTON CO., LTD.



Dr. J. A. Fleming, F.R.S., original inventor of the Thermionic Valve, writes: "You may be glad to know that with one of your AMPLION Loud Speakers I receive broadcast most splendidly."



The New
**SENIOR
 DRAGON**
 with Oak Flare, Type AR.65·0

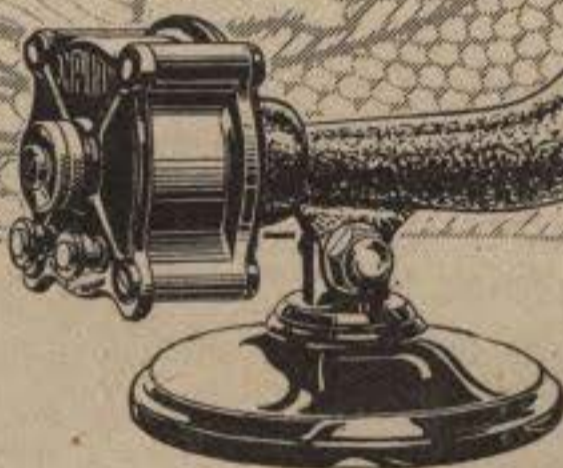

The popular "Dragon" shape—at once graceful and efficient—with wooden flare of Jacobean oak finish. Improved appearance—pleasing mellow tone.

A full size, well-designed, well-balanced and exceedingly efficient Loud Speaker with the Amplion Hall-Mark for three pounds eighteen shillings and sixpence.

£3·18·6 **AMPLION**

Other Models from 38/- to £13·13·0

The world's Standard wireless Loud Speaker.



The Cosmos Valves are very fond of the plaintive and pastoral character of the oboe. They reproduce it most carefully.

Cosmos Valves bring the music nearer; they make the music clearer; and yet they are no dearer than any other valves.

Cosmos
RADIO VALVES

from Wireless Dealers
everywhere.

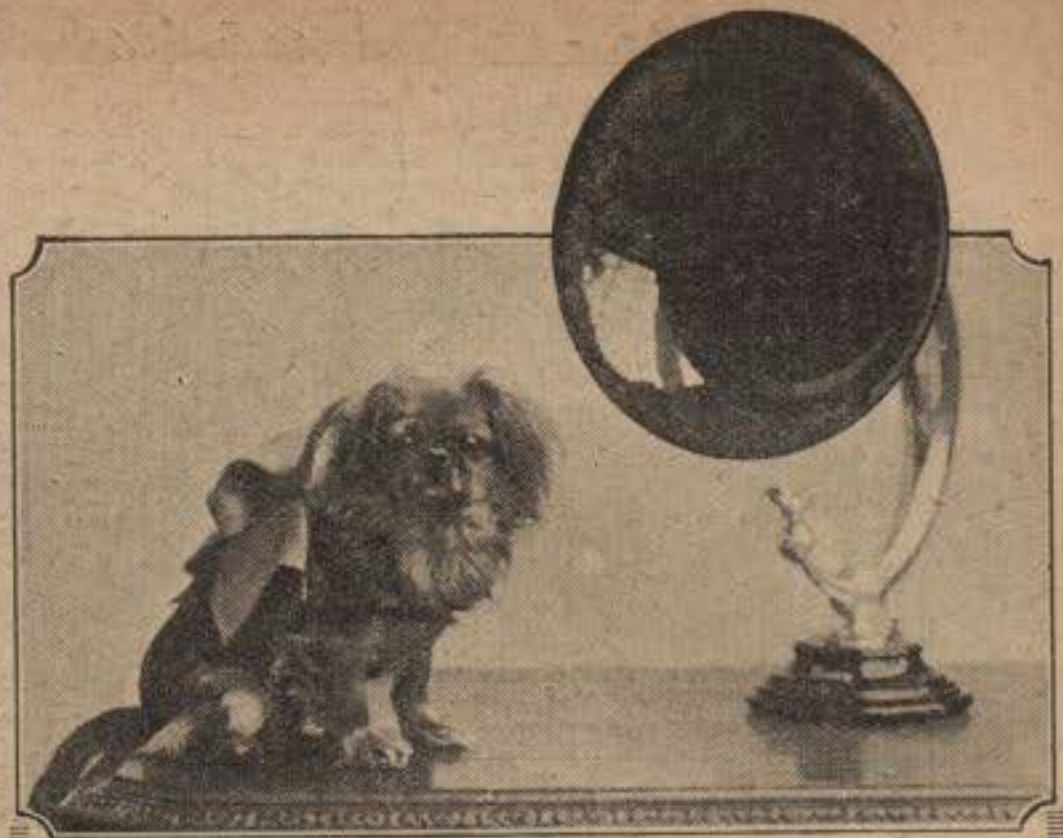

A pedigree that bears any comparison

THE dog-fancier first looks to the pedigree before he buys an animal. The connoisseur in wines wants to know something of the age and history of a wine before he makes his choice. The man who wants the finest car that money can buy enquires after the record of a particular make before he places his order. So the enthusiast who want the very best in Loud Speakers must know something of a maker's record before he makes his choice.

If you seek the very best, the most luxurious loud speaker which can be obtained, your investigations will lead you to that aristocratic instrument, the **Brown 'Q'**.

For you will learn that the pioneers of the loud speaker in this country were S. G. Brown Ltd. That, in the years that have followed, all the resources of England's foremost telephone experts have been steadily engaged in perfecting the **Brown**. You will come to know the infinite purity of tone which has resulted. That this **Brown** progress has culminated in the production of the finest and most luxurious of all Loud Speakers—the **Brown 'Q'**. An instrument which gives a fidelity of reproduction which must be heard to be believed.

The **Brown 'Q'** shown above is worth every penny of its **15 Gns.** (There are also eight other Models down to 50/-.) See your Dealer.

S. G. BROWN, LTD., Wales Farm Rd., N. Acton, W.3

Retail Showrooms: 19, Mortimer St., W.1; 15, Moorfields, Liverpool; 67, High St., Southampton; Wholesale Depts: 2, Lansdown Place West, Bath; 120, Wellington St., Glasgow; 5-7, Goswin St., Bradford; Cross House, Westgate Road, Newcastle; Howard S. Cooke & Co., 39, Caroline St., Birmingham; Robert Garmany, Union Chambers, 1, Union St., Belfast, N. Ireland.

Brown

Q Loud Speaker

"RADIANO"
the new system
of simplified
wiring.



PERCY W. HARRIS'S
Great New Invention for
Wireless Constructors

An entirely new system of set building called "Radiano" is introduced by the "WIRELESS CONSTRUCTOR" to-day. The system is explained fully by means of full size drawings on an elaborate blue print chart. All components are shown in position so that the veriest novice can immediately build a modern efficient receiver without the possibility of a mistake. The wiring up has been simplified to such an extent that the beginner can obtain results equal to those of the experienced constructor. The RADIANO chart shows the exact length of wire for every lead and abolishes the laborious work of measuring and bending stiff wire until by trial the best shape is found.

The RADIANO system marks a new milestone in home wireless construction, for with one blow it has demolished all the difficulties connected with the wiring up of a set and gives the beginner an equal chance with the expert. Get the FREE CHART to-day and have your "Radiano Three" WORKING THIS WEEK-END.

FREE

Large Blue-Print Chart
in to-day's issue of

The **Wireless
Constructor**

FOR MARCH

Published by the Amalgamated Press, Ltd.

PRICE 6^d.

"Splendid
That's a winner"



Without
Cost

Personal experience counts when a man comes to choose something for himself—for his home. There in your own arm-chair you have the ideal conditions for testing our bold claims for the CLIMAX CHELLO LOUD SPEAKER.

You must hear it at home because:

Every musical note and voice intonation from lowest fundamental to highest overtone is reproduced perfectly. Ordinary loudspeaking becomes monotonous, but the lovely tones of the CHELLO will exhilarate you.

You must see it at home because:

You will be impressed with its large size, which is the secret of its excellent volume, and by its handsome cabinet which gives that air of distinction.

OUR SPECIAL OFFER TO YOU.

Take this advertisement to your radio dealer. He can then get you a Climax Chello on approval for three clear days. Should you wish to retain it you will do so knowing that its splendid performance has doubled your pleasure in radio. If you cannot arrange through a dealer, please send direct to us.

MODEL AND PRICES:—

CLIMAX CHELLO, Cromwell Model, in Oak, 63/-.

CLIMAX CHELLO, De Luxe Model, in Mahogany, 105/-.

**CLIMAX
CHELLO**

Climax Radio Electric Ltd., Quill Works, Putney, London, S.W.15

All communications to above address.

Phone: Putney 2509.

Showrooms: 257, High Holborn, London, W.C.2.

Phone: Holborn 2538.

SPECIAL OFFER. COUPON. SPECIAL OFFER.

I should like to test the CLIMAX CHELLO Loudspeaker in my own home in accordance with your special offer. I will deposit the value of the model-marked above as a guarantee of good faith, and you will refund my payment in full if I return the instrument in good condition three days after receipt.

Name.....

Address.....

Dealer's Name and Address.....

If the dealer has no CLIMAX CHELLO available, he can get one on approval by sending this coupon.

Merely fill it with acid—within an hour it is ready for use



The
**OLDHAM
O.V.D.**
—the only Accumulator with a laminated plate

5/6

Capacity 10 amp. hrs.
Fully Guaranteed.

Something quite new in Accumulators

HERE'S a new and better Accumulator specially designed for use with Dull Emitter valves. It fairly bristles with revolutionary ideas. First of all no first charge is required. Merely fill it with acid—within an hour you can use it with your Set. No chance of being disappointed or missing a programme.

Then, again, owing to its special plates it holds its charge much longer than any other type of Accumulator. It is particularly free from sulphation—even if left for comparatively lengthy periods.

When it requires recharging any garage will do it within 8 hours—instead of the 30 or 40 hours usually required with the ordinary slow-discharge accumulator. Its laminated plates permit free circulation of electrolyte. See your Dealer about one to-day—no other Accumulator at anything near the price can give such long and economical service.

What the
O. V. D.
will do:

Used with the new 1 amp. Dull Emitter Valves an O.V.D. will give the following hours of continuous service without re-charging: 1-valve Set, 180 hours; 2-valve, 70 hours; 3-valve, 40 hours; 4-valve, 30 hours.



OLDHAM & SON, LTD.
Works: Denton, Manchester.
Telephone: Denton 121.

London Office and Depot: 6, Eccleston Place, Victoria, S.W.1.
Telephone: Sloane 2701.

Glasgow Office: 120, Wellington Street.

Gilbert Ad. 7873.

SAXON GUIDE TO WIRELESS

IF YOU WISH TO MAKE WIRELESS INSTRUMENTS WHICH ARE UNBEATABLE IN PRICE, QUALITY, OR EFFICIENCY, THIS IS THE BOOK YOU MUST HAVE. EVERYTHING ABOUT WIRELESS IS SO CLEARLY EXPLAINED THAT ANY BEGINNER CAN MAKE THE MOST EFFICIENT SETS OBTAINABLE. FULL INSTRUCTIONS WITH CLEAR WIRING DIAGRAMS are given for making COMPLETE CRYSTAL SETS, SINGLE VALVE SETS, ONE AND TWO-VALVE AMPLIFIERS, DUAL AMPLIFICATION SETS, TWO, THREE AND FOUR-VALVE TUNED ANODE ALL-WAVE RECEIVERS; ALSO THE VERY LATEST FIVE-VALVE RESISTANCE CAPACITY RECEIVER. The exact cost of each set is clearly stated.

NO SOLDERING. NO DRILLING. NO KNOWLEDGE REQUIRED. 176 PAGES
The chapter on testing wireless components is alone worth the price of the book. Price 1/3 post free.

SPECIAL APPROVAL OFFER

If desired, this book will be sent on approval on receipt of your promise to remit 1/3 or return the book within seven days.

SAXON RADIO CO. (Dept. 20), SOUTH SHORE, BLACKPOOL.

ADANA AUTOMATIC SELF-INKING PRINTING MACHINE

45/- COMPLETE PLANT



THIS massively constructed Printing Machine is the most wonderful of its kind. There are now over 10,000 users of these plants, many saving enormously in their own work, others making an excellent living.

Will print any class of matter from a CHEMIST'S LABEL to an ILLUSTRATED MAGAZINE including Perforating, Creasing and Box-making. The finest malleable iron and mild steel used in construction. Simplicity to the extreme. No special skill required. Large numbers of boys are producing their School and Scout Magazines. Printers' metal type, case, complete accessories, and excellently illustrated instructional book included. Illustrated particulars in two colours, and samples of work, sent on receipt of stamped addressed envelope. Also sold by small weekly instalments. Ask for Terms.

THE "ADANA" AGENCY (Dept. R.T. 17), 34, King St., Twickenham, Middx.

Printers should write for particulars of new system of supplying First-class Founders' Type.

MULTIPLE CONNECTOR EELX TREBLE DUTY TERMINALS



8-way cords, 3/6 each set.
8 single wires, different colours, 1 1/2d. yd.

Write for complete list B.T.L.

Obtainable at your trader. If in difficulty write to us.

J. J. EASTICK & SONS
EELX HOUSE,
115, BUNHILL ROW, LONDON, E.C.1.

For every purpose the EELX Treble duty Terminal stands supreme. It provides for holding plug, pin eye or spade adaptor, or wire of any gauge. Slotted stem allows of neat connection under the panel without soldering.

Price, T2 LC with indicating top, 4/6d.

Price, T21, with plain top, 3d. Nickel finish.



Learn to Play JAZZ!

If you can play the Piano, you, too, can become a real dance Pianist!

Billy Mayerl

the world's greatest syncopated pianist and radio favourite, will teach you through the post by his wonderful new method. Easy—rapid—fascinating. Hundreds already successful. Write now for FREE book and full particulars. BILLY MAYERL SCHOOL (Dept. B), 29, Oxford St., London, W.1



Standard Wet (Leclanche Type) H.T. Batteries, 3d. a volt

This source of H.T. supply is absolutely ideal, being simple to fix, cheap and silent in operation. The cells consist of containing Jar, Zinc and Sac element in a solution of Sal ammoniac. Send 1/2d. stamp for full particulars.

Price per dozen.		Price per dozen.	
No. 1 Sac for 7 milliamps ...	1/6	Zincs ...	1/-
Ditto with terminals ...	2/3	Packets of 24 Rubber Rings for insulating 12 Sacs, 6d. (state if No. 1 or No. 2 Sac). Carriage extra.	
No. 2 Sac for 15 milliamps ...	3/-		
Ditto with terminals ...	3/9		
Jar (Waxed) ...	1/3		

WET H.T. BATTERY CO., 23, Coldharbour Lane, Camberwell Green, S.E.5.
Phone: Brit. 2539.

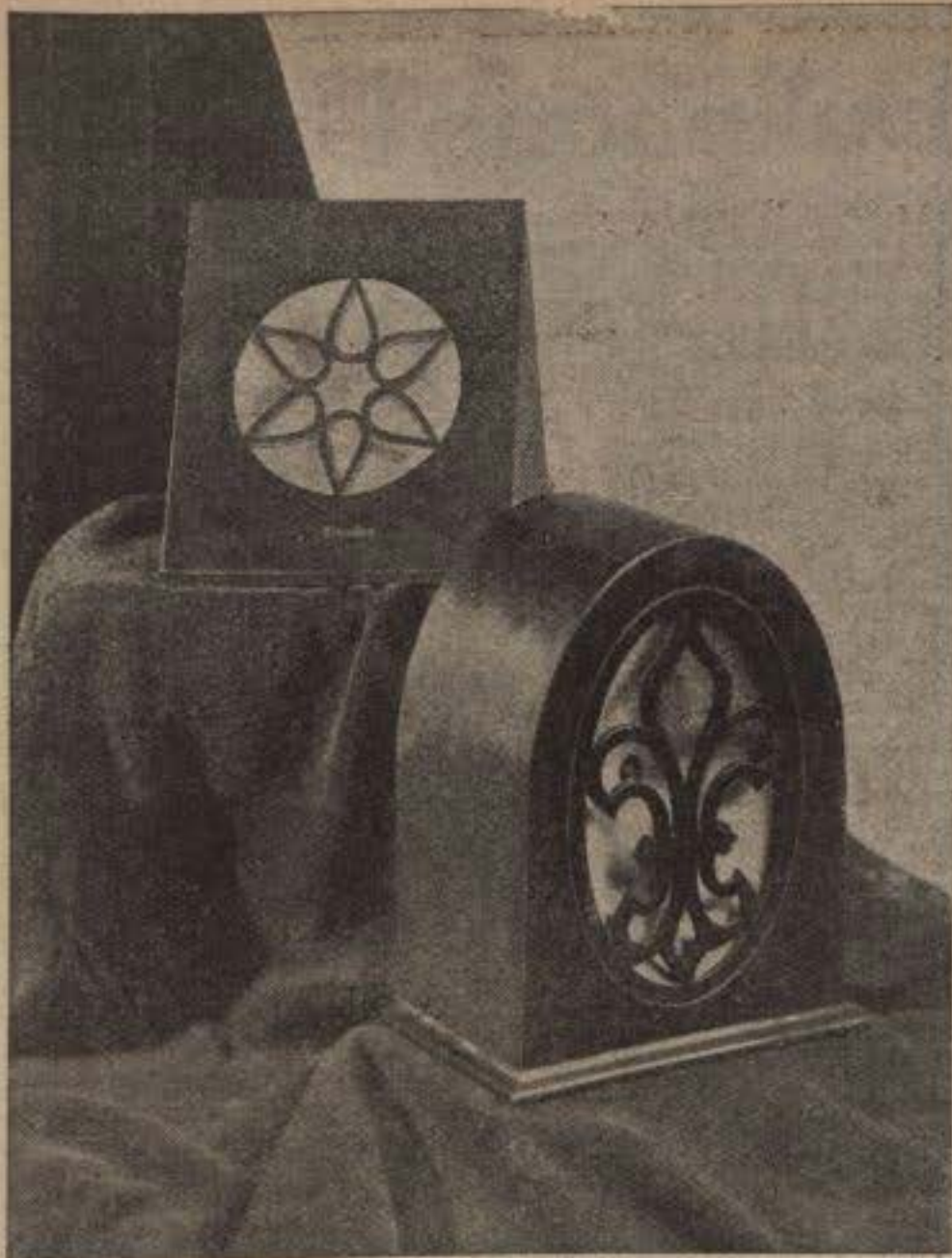

THE BEST CONES IN 1927

THE Ellipticon has been described as "the best loudspeaker on the market" by one who is fully qualified to judge, and who has no personal interest in our success. And we honestly consider that it is one of the best instruments we have ever turned out. The Tablecone, too, can really be said to be superior to similarly priced Cones.

THE TABLECONE
(Trade-mark)

The cone is housed in an attractive cabinet of unique design, which has a walnut finish. The circular diaphragm has an extremely sensitive driving unit which brings a wealth of volume with pure and effortless ease. The magnet in the cone unit is unusually large. The instrument is supplied complete with cord connection, and is a proposition of excellent value. It has a genuine claim to be better than any similar instrument at the price. Height 10 ins., breadth 11 ins. at base, depth 9 1/2 ins. **£2:15**

THE ELLIPTICON
(Registered Trade-mark)

The handsome cabinet is finished in dark walnut and will admirably harmonise with any decorative scheme or furnishings. The elliptical concavity of this casing reflects the full body of sound with wonderful depth and sweetness. The large vibrating area of the cone, together with a driving unit of special design, brings pleasing and natural tone with plenty of power. The magnets in the cone unit are very large. There is no diaphragm, but a small armature which, reacting to the faintest impulse, faithfully reproduces extremely low and high tones. Height 13 1/2 ins., depth 7 ins., width 10 1/2 ins. **£5:10**

Brandes
From any reputable Dealer

BRANDES LIMITED, 296, REGENT ST., LONDON, W.1.



Handphones which pamper our liking for real comfort

HAVE you ever, when lying back in your chair listening-in, felt that the only thing which prevented complete repose was the pressure of the headphones on your head? Perhaps not. six ounces of Brown Featherweights can hardly be felt. But perhaps you have an inherent distaste of the headband. People have, you know! If you have, you need Brown Handphones. Brown Handphones have no headband. They are made expressly for those who dislike a headband. They are made for comfort. Supreme, conscious comfort. Each earpiece of a Brown Handphone is cunningly designed to fit closely, yet without pressure, over the ear. Close enough to

allow every sound of the broadcast to be clearly heard. Yet not so close that even the slightest hurtful pressure is felt upon the ears.

Brown Handphones embody the identical mechanism which gives to Brown Headphones such a sweet, pure tone and such a fine degree of sensitivity.

Now... lie back in that chair, with only the fire for light, Brown Handphones to ears, and enjoy the evening's broadcast in utter and complete repose.

Brown Handphones come in three types. They are: 'F' type, single 12/6; Double 28/-, 'A.2' type, single 22/6; Double 28/-, 'A' type, single 35/-; Double 60/-. At your Dealer's on your way home.



S. G. BROWN, LTD., Western Ave., N. Acton, W.3

Retail Showrooms: 19, Mortimer Street, W.1; 15, Moorfields, Liverpool; 67, High Street, Southampton. Wholesale Depots: 2, Lansdown Place West, Bath; 120, Wellington Street, Glasgow; 5-7, Godwin Street, Bradford; Cross House, Westgate Road, Newcastle; Howard S. Cooke & Co., 59, Caroline Street, Birmingham, Robert Germany, Union Chambers, Union Street, Belfast, Northern Ireland.

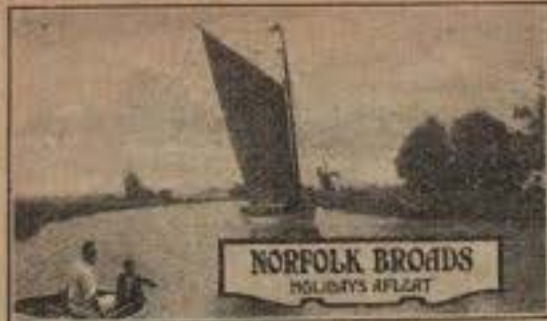

YOUR HOLIDAY

THIS year try the holiday that is different. Explore new country and enjoy healthy, restful change, free from irksome routine.

THE NORFOLK BROADS,

with their natural beauty and quiet old-world villages, will enchant you. They are 120 miles from London, and consist of 200 miles of safe inland rivers and lakes, situated between Cromer, Lowestoft, and Norwich. You hire from us for a week or longer a fully furnished wherry, yacht, or motor-boat, which becomes your floating home, moving when and where you wish, inland, not on the sea. We can supply an attendant to manage the boat and do all cooking. You only have to enjoy yourself. The cost, including boat, food, etc., averages £4 per head per week. *Special terms for Easter.*

Free: 212-page booklet, "How to Enjoy a Broads Holiday," containing details of 300 yachts, wherries, motor-boats, houseboats, bungalows we have for hire.

ALL OWNERS' CRAFT ARE INCLUDED IN THIS BOOKLET.

BLAKE'S LTD. 19 Broadland House,
22 Newgate Street,
LONDON, E.C.1.

Train Services, fares and other information from any L.N.E.R. or L.M.S. Enquiry Office.

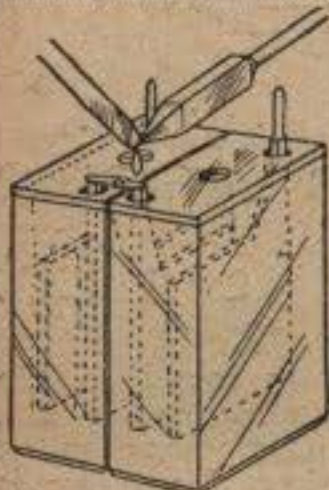

MAKE YOUR OWN H.T. ACCUMULATORS AND SAVE HALF THE COST.

Easily assembled in two hours. Re-charge every 7-8 months. Capacity 3,000 milli-ampere hours.

Champion H.T. parts are guaranteed, made of best quality all British material, they have stood the severest tests, and have a 20% higher capacity than many other well-known makes at nearly double the price.

The Plates are manufactured under a new patent process entirely different from other types. They will stand the charge for seven to eight months without deteriorating or sulphating, and with ordinary care will last for years.

Champion H.T. Accumulator Parts are very easy to assemble, in fact, so simple, that anyone without experience will find it almost impossible to go wrong, and a 60 volt H.T. can easily be completed in a couple of hours.

Champion Parts are obtainable from all leading Dealers, or post free direct from the Manufacturers. Write for free instructions and illustrations to:-

CARRIER FREE. With every 40 or 60 volts of Champion H.T. Accumulator Parts, a Carrier for 8" size is given FREE.

THE CHAMPION ACCUMULATOR CO.,
2, PREBEND STREET, LEICESTER.

YOU SHOULD RESOLVE TO BANISH YOUR DEAFNESS

GENERAL ACOUSTICS LTD.,
77, Wigmore Street, London, W.1.

Also at 24, St. Ann's Square, Manchester; 601, Corporation Street, Birmingham; 7b, Buchanan Street, Glasgow; 19, St. Andrew's Place, Edinburgh.

1927 can bring you PERFECT HEARING by way of the NEW Acousticon—the smallest, lightest, and most inconspicuous aid ever invented. If it is good enough for the GREATEST LOND ON HOSPITALS to use EXCLUSIVELY and the world's leading EAR SPECIALISTS to widely recommend, it is surely good enough for you.



A NEW YEAR AND—NEW HEARING

THE NEW ACOUSTICON
THE AID YOU MUST TRY
IN 1927



EKCOLE LTD

"EKCO" H.T. UNITS SCRAP DRY BATTERIES!

by obtaining H.T. Current from electric supply mains (D.C. & A.C.) by just attaching Adaptor to electric light lamp-holder!

SAFE! SILENT! SOUND!

The "QUALITY" Unit UNITS TO SUIT ALL SETS from 42/6.

ILLUSTRATED FOLDER FREE!
(Dept. H.), 5B, LONDON ROAD, WESTCLIFF-ON-SEA.

THIS IS THE M.A.P. STRETLINE CONDENSER

21/s. Altogether this Condenser gives an entirely new meaning to tuning. It resolves it into a perfectly simple operation and the average person has no difficulty without any technical knowledge or skill in tuning in distant stations which on the standard type of Condenser used to-day are extremely difficult.

Sole Agents Wanted in All Towns.
M.A.P. Co., 246, Gt. Lister St., Birmingham.



THE OFFER THAT AMAZED THE WIRELESS WORLD.

Bullphone Units at

15/-
EACH

To say that the wireless community was amazed at our offer of "Bullphone" Gramophone Attachments at 15/- each is putting it mildly. Our first offer of 5,000 was snapped up in a few days. These goods are absolutely new genuine articles, not cheaply made for this special offer.

Reduced from 32/6.

The excellent reproduction of the "Bullphone" Unit is well known in wireless circles all over the World and carried all before it in severe tests at the Toronto Wireless Exhibition, White City Exhibition, Leipzig Fair and most of the more important wireless exhibitions.

The diaphragm of the "Bullphone" Unit is

THREE TIMES AS LARGE AS OTHERS AT A SIMILAR PRICE

and is as large as others at three times the price, producing enormous volume and exceptionally clear tone. The "Bullphone" is the original non-metallic unit now copied by many well-known manufacturers proving the superiority of the "Bullphone."

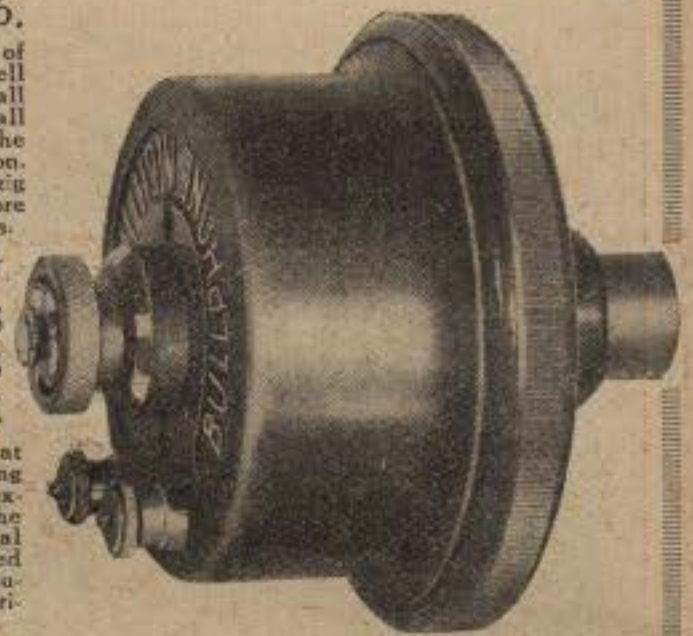

Order to-day from your local dealer, or send cash direct to us.

CASH PRICE 60/-
POST FREE.



Don't be ill-tempered

because results from your set are not what you expected. For purer and louder reproduction get a

BULLPHONE NIGHTINGALE De Luxe Speaker

guaranteed superior to others, absolutely regardless of price. Will not overload 2 to 10 valves.

CASH or EASY TERMS

5/-

deposit secures this Super Speaker, and 12 monthly payments of 5/- completes purchase, or can be obtained post free for 60/- cash.

If your dealer does not stock "Bullphone" Speakers, send your order with cash and his name and address to us.

W. BULLEN (Dept. R.T.II),
38, HOLYWELL LANE, E.C.2

DEALERS: For Bullphone terms see the current number of the "Radio Times".

TWO ESSENTIALS FOR IMPROVING YOUR WIRELESS



POST FREE 8/6

No alterations to your set. Fixed in a few moments.

VERNIANO B CLARKE'S ATLAS APERIODIC COUPLER

Fits 3-16", 4" and 5" H.A. Condensers, Ratio 50:1. No Backlash. Converts ordinary condensers into super-vernier type.

Fits into the core of almost any coil. Greatly increases selectivity. Only to be used on sets with no stage of H.F.

If you cannot get them from your dealer, send direct to the makers.
H. CLARKE & CO. (Mer.) Ltd.,
"Atlas" Works, Old Trafford, Manchester.



POST FREE 8/-

A 3-VALVE SET FOR £5-17-6

(Excluding Equipment and Mains Supply)
THE NEW CHAKOPHONE "JUNIOR THREE"
Of similar design to the "JUNIOR TWO," but larger, this handsome yet inexpensive 3-valve set will be found as efficient as sets costing considerably more. Tuning-in is extremely simple and a De Luxe 3-way switch is fitted allowing 2 or 3 valves to be operated, the central position switching off all batteries.

Made by the makers of the famous No. 1 set.
EAGLE ENG. CO., LTD., WARWICK.
London Depot: 8, Gt. Russell Street, W.C.1.
Send for further particulars.

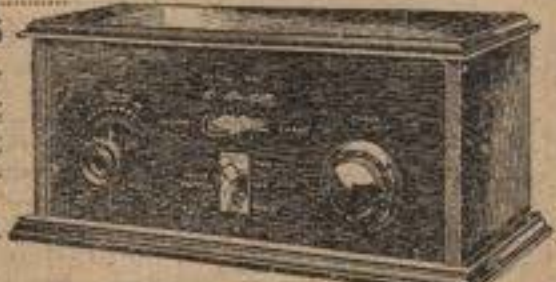

Hints for Everyday Meals by the Bisto Chef.



Steak and Kidney Pie

"Next time you're making a Steak and Kidney Pie, make it just twice as good by using Bisto. Sprinkle the meat with Bisto before putting on the pie crust. You will then get a tasty, appetising pie with a thick, rich, jelly-like gravy, deliciously flavoured. What an improvement! A 2½d. packet of Bisto lasts a family a week."

BISTO
For all
Meat Dishes

This is the amazing loudspeaker that brings in bass drums and highest soprano notes with perfect realism

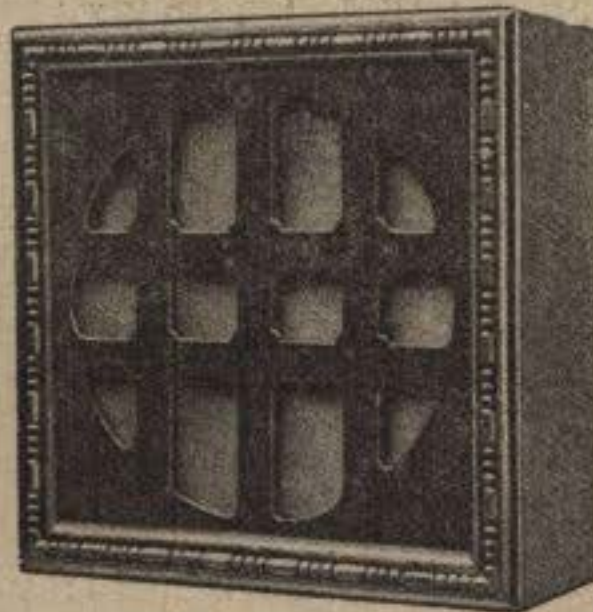

Never has such astoundingly true reproduction been heard before! The subtlest shades of tone, the highest notes and the lowest, come through exactly as they are created by the artists. Even wireless dealers say they have never heard anything so good—or sold anything so readily.

Seven Days Free Test!

Ask your local dealer to let you hear the M.P.A. Speaker or send a card and have one to try for a week on your own set. No charge and no obligation to buy. Table Plaque 45/-; Table Cabinet (as shown) 57/6; Table Grand 77/6

M.P.A.
Sprung-Diaphragm Speaker

Ask also for the new book of the wonderful M.P.A. no-aerial, no-earth Portable Sets.
M.P.A. WIRELESS (DEPT. 4), 42, CONDUIT STREET W.1
Phone: Gerrard 684-7 Trade enquiries are invited

Remarkable success of the British Valve with the distinctive base and the extraordinary performance.

Opportunity was given recently for thousands of wireless users to try out the new Octron valve.

Remarkable success attended the enterprise, they found that the Octron gave their sets greater range, purer volume with marked economy. They found, too, that the unusual base design made for easier handling and insured itself against breakage.

Withhold judgment of your set until you have tried Octron Valves

REDUCED PRICES

2, 4 or 6
valve Detector or
L.F. Amplifier
10/-
Power Valves
15/-

OCTRON
The Valve with the Octagonal Base

OCTRON LTD.
18, Howick Place, S.W.1
32, Charlotte St, B'ham

If in doubt what type of valve you require send us particulars of your set.

There's more than strength in the wonderful P.M. Filament there's proved lasting merit and good music



THE strength of the wonderful P.M. Filament is unrivalled.

More than a year ago it was demonstrated that after a 1000 hours' life this amazing filament could be tied in knots and support four Mullard P.M. Valves without breaking.

Then the test report of the National Physical Laboratory established conclusively the consistent high service, generous value and long life to be secured from valves with the Mullard P.M. Filament.

This published report of an official Government Laboratory test was distributed to the radio public for the first time in valve history.

The superior qualities of the Mullard P.M. Filament are many. They claim the attention of every man who owns a radio receiver.

From the moment Mullard P.M. Valves are inserted into your receiver, they bring renewed pleasure to your radio. Music in all its natural beauty is reproduced with life-like truth. Call in at your nearest radio dealer to-day and obtain full particulars of Mullard P.M. Valves with the wonderful P.M. Filament.

For 5-volt accumulator
THE P.M.1 H.F. 0.1 amp. 14/-
THE P.M.1 L.F. 0.1 amp. 14/-
THE P.M.2 (Power) 0.15 amp. 18/6

For 4.5-volt accumulator or 3 dry cells
THE P.M.3 (General Purpose) 0.2 amp. 14/-
THE P.M.4 (Power) 0.1 amp. 18/6

For 6-volt accumulator or 4 dry cells
THE P.M.5x (General Purpose) 0.1 amp. 14/-
THE P.M.5B (Resist. Capacity) 0.1 amp. 14/-
THE P.M.6 (Power) 0.2 amp. 18/6

Super power valves for last L.F. stage
THE P.M.234 (4 volts 0.25 amp) 22/6
THE P.M.256 (6 volts 0.25 amp) 22/6

Sectional view of P.M.5 showing generous proportions of P.M. Filament

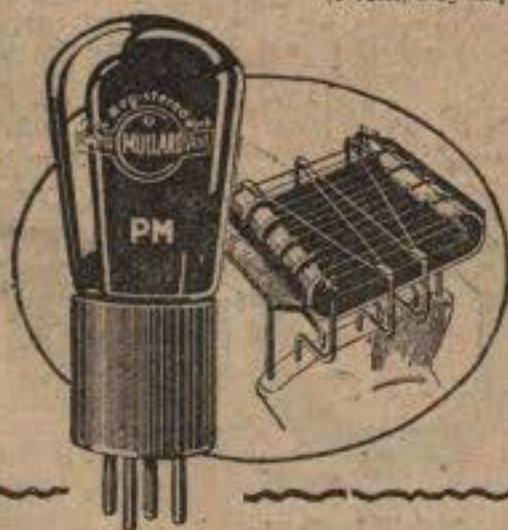

Mullard
THE · MASTER · VALVE

ADVT. THE MULLARD WIRELESS SERVICE CO., LTD., MULLARD HOUSE, DENMARK STREET, LONDON, W.C.2.